

Save These Instructions!  
Conservez ces instructions!  
Bewahren Sie diese Anweisungen auf.  
Conservare questo manuale!  
Guarde estas instruções!  
Φυλάξτε αυτές τις οδηγίες!  
¡Guarde estas instrucciones!  
Bewaar deze gebruiksaanwijzing!  
请保存好本说明!

# TOSHIBA



## TCB-SC642TLE

Central Remote Controller for Split System Air  
Conditioner

Télécommande centrale pour climatiseur à  
système deux blocs

Zentrale Fernbedienung für Klimagerät mit  
Splitbauweise

Centralina di controllo a distanza per  
condizionatore d'aria di tipo split

Controlador remoto central para aparelho de  
ar condicionado com sistema split

Κεντρικό τηλεχειριστήριο για διαχωρισμένο  
σύστημα κλιματισμού

Controlador remoto central para  
acondicionado de aire de sistema split

Centrale afstandsbediening voor dubbel-  
systeem airconditioner

分体系统空调机的中央遥控器

• *OWNER'S MANUAL*

• *MANUEL DU PROPRIÉTAIRE*

• *BENUTZERHANDBUCH*

• *MANUALE D'USO*

• *MANUAL DO PROPRIETÁRIO*

• *ΕΓΧΕΙΡΙΔΙΟ ΧΡΗΣΤΗ*

• *MANUAL DEL PROPIETARIO*

• *GEBRUIKSAANWIJZING*

• *用户手册*

**EG**

**F**

**D**

**I**

**P**

**GR**

**ES**

**NE**

**CS**

Pub. OI-85464189673000

TOSHIBA CARRIER CORPORATION

# Contents

	Page
Product Information.....	2
Alert Symbols.....	2
Installation Location .....	3
Electrical Requirements .....	3
Safety Instructions.....	3
How to Use the Central Controller .....	4
■ Functions of buttons .....	4
■ Display .....	7
■ How to start group operation .....	8
■ How to start collective operation .....	9

## Product Information

If you have problems or questions concerning your Air Conditioner, you will need the following information. Model and serial numbers are on the nameplate on the bottom of the cabinet.

Model No. TCB-SC642TLE Serial No. \_\_\_\_\_

Date of purchase \_\_\_\_\_

Dealer's address \_\_\_\_\_

Phone number \_\_\_\_\_

### DECLARATION OF CONFORMITY

This product is marked « **CE** » as it satisfies EEC Directive No. 89/336/EEC, 73/23/EEC and 93/68/EEC.

This declaration will become void in case of misuse and/or from non observance though partial of Manufacturer's installation and/or operating instructions.

## Alert Symbols

The following symbols used in this manual, alert you to potentially dangerous conditions to users, service personnel or the appliance:



**WARNING**

This symbol refers to a hazard or unsafe practice which can result in severe personal injury or death.



**CAUTION**

This symbol refers to a hazard or unsafe practice which can result in personal injury or product or property damage.

## Installation Location

- We recommend that this central controller be installed properly by qualified installation technicians in accordance with the Installation Manual provided with the central controller.



### WARNING

- Do not install the central controller where there are fumes or flammable gases, or in an extremely humid space such as a greenhouse.
- Do not install the central controller where excessively high heat-generating objects are placed.

## Electrical Requirements

1. All wiring must conform to the local electrical codes. Consult your dealer or a qualified electrician for details.
2. Wiring must be done by a qualified electrician.



### CAUTION

To warm up the system, the power mains must be turned on at least 12 hours before operation. Leave the power mains ON unless you will not be using this appliance for an extended period.

Power mains



## Safety Instructions

- Read this Owner's Manual carefully before using this central controller. If you still have any difficulties or problems, consult your dealer for help.
- The air conditioner is designed to give you comfortable room conditions. Use this only for its intended purpose as described in this Owner's Manual.



### WARNING

- Never touch the unit with wet hands.
- Never use or store gasoline or other flammable vapor or liquid near the air conditioner — it is very dangerous.
- The air conditioner has no ventilator for intaking fresh air from outdoors. You must open doors or windows frequently when you use gas or oil heating appliances in the same room, which consume a lot of oxygen from the air. Otherwise there is a risk of suffocation in an extreme case.



### CAUTION

- Do not turn the air conditioner on and off from the power mains switch. Use the ON/OFF operation button.
- Do not stick anything into the air outlet of the outdoor unit. This is dangerous because the fan is rotating at high speed.
- Do not let children play with the air conditioner.
- Do not cool or heat the room too much if babies or invalids are present.

EG





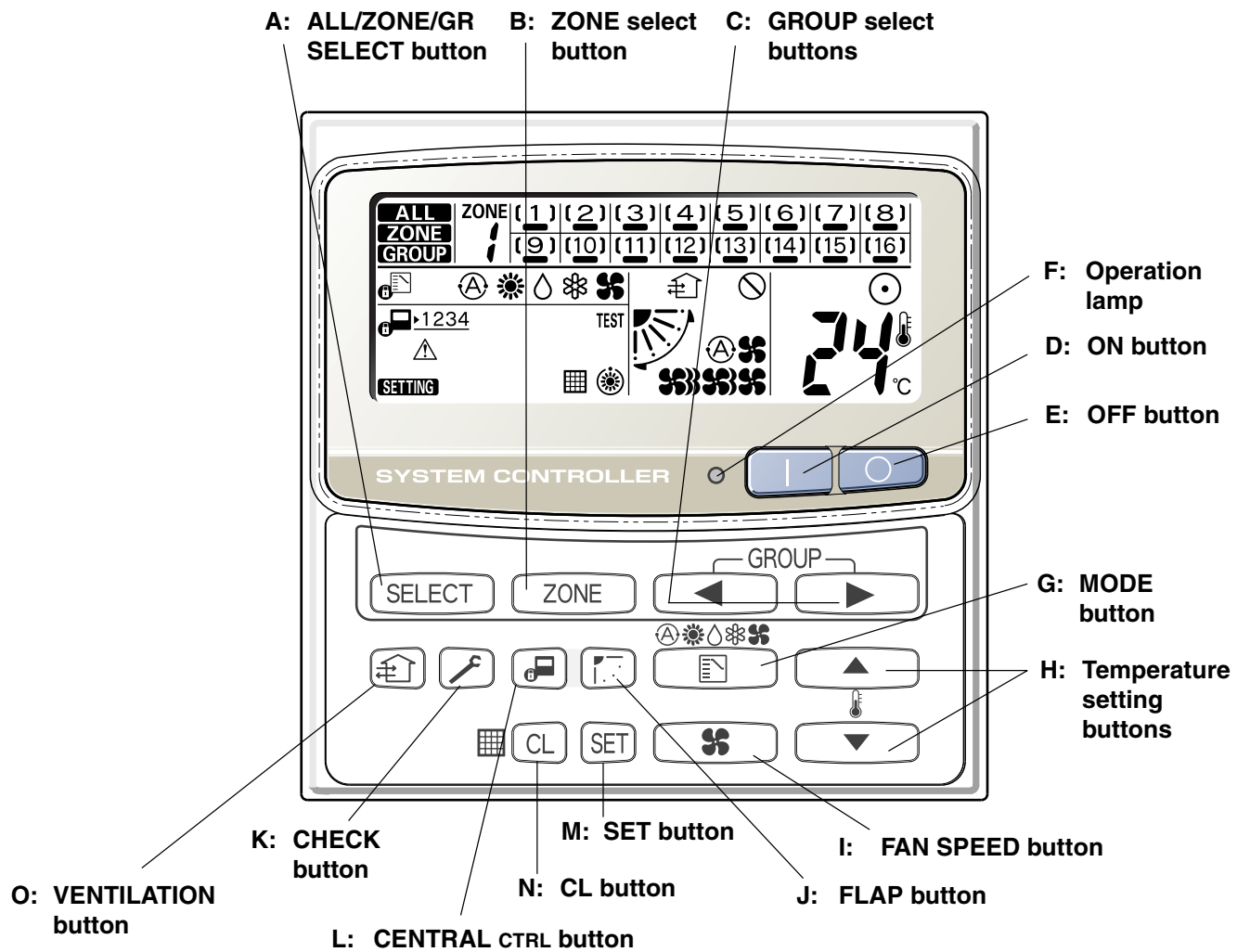







































# How to Use the Central Controller

## ■ Functions of buttons













<p><b>A: ALL/ZONE/GR SELECT button</b></p> <p><b>NOTE</b></p>	<p>Use this button to select one of the following:</p> <p><b>ALL:</b> Used for turning all the air conditioners on and off.</p> <p><b>ZONE:</b> Used for turning all the air conditioners of each zone on and off.</p> <p><b>GR:</b> Used for turning all the air conditioners of each group on and off.</p> <p><b>A maximum of four zones and 16 groups (units) in a zone can be set.</b></p>
<p><b>B: ZONE select button</b></p>	<p>Use this button to select a zone (1 to 4) to operate individually.</p>
<p><b>C: GROUP select buttons</b></p>	<p>Use these buttons to select a group (1 to 16) to operate individually.</p>

## ■ Functions of buttons (Continued)

<b>D: ON button</b> 	This button is for turning the selected air conditioner on.												
<b>E: OFF button</b> 	This button is for turning the selected air conditioner off.												
<b>F: Operation lamp</b>	This lamp lights when the unit is turned on.												
<b>G: MODE button</b>  <b>(AUTO)</b>  <b>(HEAT)</b>  <b>(DRY)</b>  <b>(COOL)</b>  <b>(FAN)</b>  <b>NOTE</b>	<p>Use this button to select one of the following five operations:</p> <p> : Used to automatically set cooling or heating operation.  <b>Some models are not provided with a mode for automatically setting the cooling or heating operation.</b>          (temperature range: 18 to 29 °C)</p> <p> : Used for normal heating operation.  <b>Only for heat pump type</b>          (temperature range: 18 to 29 °C)</p> <p> : Used for dehumidifying without changing the room temperature.          (temperature range: 18 to 29 °C)</p> <p> : Used for normal cooling operation.          (temperature range: 18 to 29 °C)</p> <p> : Used to run the fan only, without heating or cooling operation.</p> <p>When the  indication is displayed, you cannot change the mode from  and  or  to  or  and . To change the mode, turn off all units once then select the mode again.</p>												
<b>H: Temperature setting buttons</b>  	 : Press this button to increase the temperature setting.  : Press this button to decrease the temperature setting.												
<b>I: FAN SPEED button</b>  <b>(AUTO)</b> <b>(HI.)</b> <b>(MED.)</b> <b>(LO.)</b>	<p> : The air conditioner automatically decides the fan speed.</p> <p> : High fan speed.</p> <p> : Medium fan speed.</p> <p> : Low fan speed.</p>												
<b>J: FLAP button</b>     <b>CAUTION</b>  <b>NOTE</b>   <b>NOTE</b>	<p>1. Use this button to set the airflow direction to a specific angle. The airflow direction is displayed on the remote control unit.</p> <table border="1" data-bbox="802 1472 1577 1663"> <thead> <tr> <th>Operation mode</th> <th>Number of airflow direction settings</th> </tr> </thead> <tbody> <tr> <td> (COOL) or  (DRY)</td> <td>3</td> </tr> <tr> <td> (HEAT) or  (FAN)</td> <td>5</td> </tr> <tr> <td> (AUTO)</td> <td></td> </tr> <tr> <td>Cooling mode:</td> <td>3</td> </tr> <tr> <td>Heating mode:</td> <td>5</td> </tr> </tbody> </table> <ul style="list-style-type: none"> <li>In the cool mode and dry mode, when the flaps are set in a downward position, condensation may form and drip around the vent.</li> <li>Do not move the flap with your hands.</li> </ul> <p>This function is available only for 4-Way air discharge cassette type and Under ceiling type.</p> <p>2. Use this button to make the airflow direction sweep up and down automatically. Press this button several times until the  symbol appears on the display.</p> <p>1) The flap setting can be performed only for units that have no remote controllers.          2) In the ALL or ZONE mode, no flap setting can be performed. If necessary, you should select the GR mode and use the FLAP button.</p>	Operation mode	Number of airflow direction settings	 (COOL) or  (DRY)	3	 (HEAT) or  (FAN)	5	 (AUTO)		Cooling mode:	3	Heating mode:	5
Operation mode	Number of airflow direction settings												
 (COOL) or  (DRY)	3												
 (HEAT) or  (FAN)	5												
 (AUTO)													
Cooling mode:	3												
Heating mode:	5												

EG

### ■ Functions of buttons (Continued)



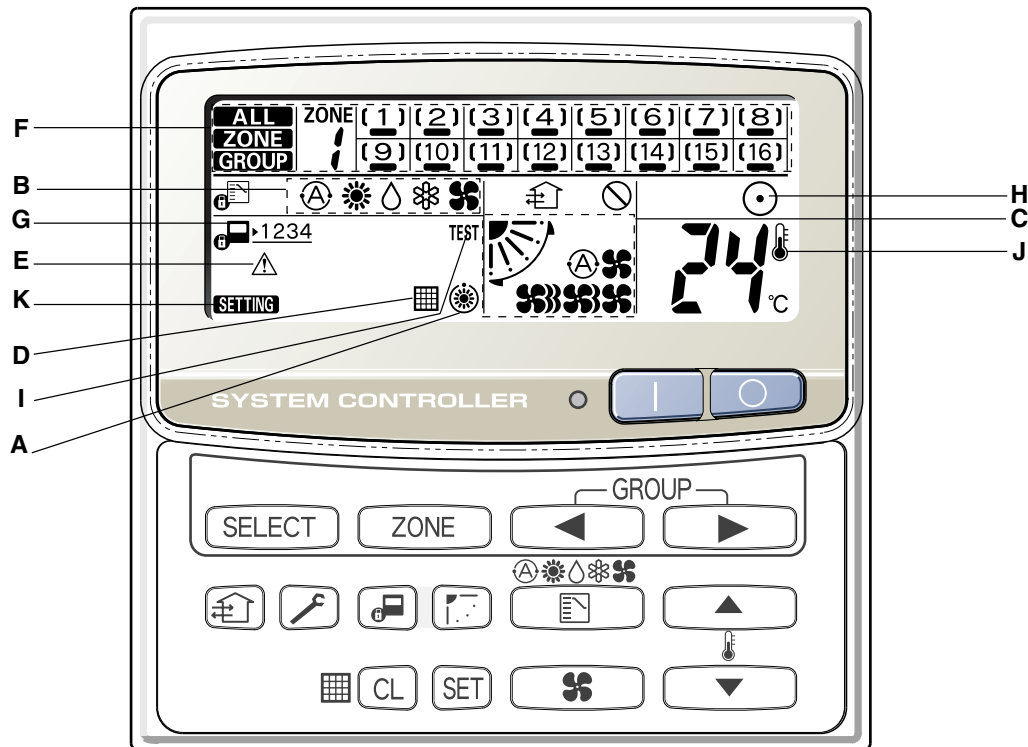

<p><b>K: CHECK button</b> </p> <p> <b>CAUTION</b></p>	<p>This button is used only when servicing the air conditioner.</p> <p><b>Do not use the CHECK button for normal operation.</b></p>
<p><b>L: CENTRAL CTRL button</b> </p>	<p>Use this button to inhibit individual operation by remote controller as follows:</p> <p> 1234</p> <ol style="list-style-type: none"> <li>1: Individual ON/OFF operation is inhibited.</li> <li>2: Individual ON/OFF, MODE and Temperature setting operation is inhibited.</li> <li>3: Individual MODE and Temperature setting operation is inhibited.</li> <li>4: Individual MODE operation is inhibited.</li> </ol> <p>No indication: Central control is cleared. (Individual operation)</p>
<p><b>M: SET button</b> </p> <p><b>NOTE</b></p>	<p>This button is used for setting indoor unit's address when installing the air conditioner.</p> <p><b>Do not use the SET button for normal operation.</b></p>
<p><b>N: CL button</b> </p>	<p>Use this button to reset the filter sign .</p> <p>The air conditioner has the timer for the filter and informs you when the filter needs cleaning.</p>
<p><b>O: VENTILATION button</b> </p>	<p>Use this button when you installed a fan available in the market. Pressing this button turns on and off the fan.</p> <p>When turning off the air conditioner, the fan will also turned off. While the fan is operating,  will appear in the display.</p> <p>If  is displayed when pressing the ventilation button, no fans are installed.</p>

## ■ Display



### Description

- A:** When the unit is in the heating standby mode, the  indicator appears.
- B:** The currently selected operation mode is displayed.
- C:** The currently selected FAN SPEED, Airflow Direction and SWEEP settings are displayed.
- D:** This indication appears when the filter needs cleaning.
- E:** This indication appears only when an abnormality occurs within a unit.
- F:** The currently selected mode (ALL, ZONE or GROUP), ZONE number and GROUP number are displayed.

-  GROUP number display (no figure: no number registered)
-  GROUP state display ( [ ] : registered group,  : currently selected group)
-  Operation state display ( — : on, no sign: off,  : alarm)

- G:** The currently selected central control mode (1, 2, 3 or 4) is displayed.
- H:** Lights when any of the air conditioners under the central control is operating; turns off when none of the air conditioners under the central control is operating. Blinks when any conditioner is operating under abnormal conditions and its protection functionality is working.
- I:** This indication appears while a test run is underway.
- J:** This indication appears when the temperature is set.
- K:** When turning on the power switch of the central controller, **SETTING** sign blinks for a few minutes. While blinking, any controls using the central controller are inhibited. This is because the central controller is verifying connected groups.

**EG**

## ■ How to start group operation

To start group operation

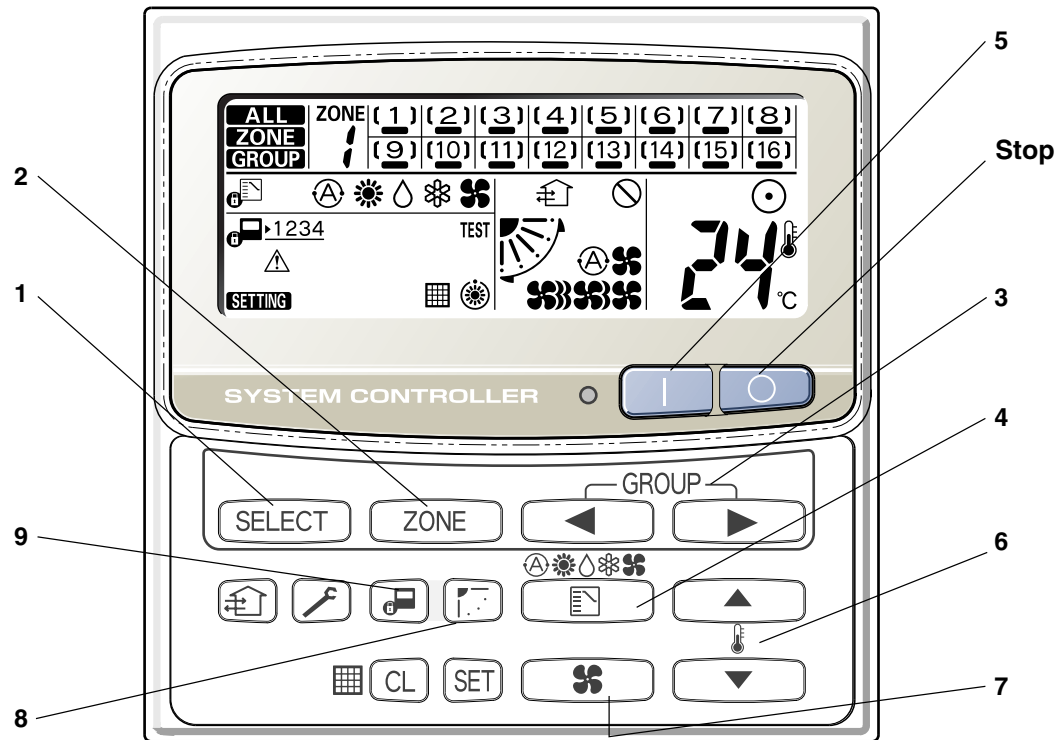

<b>Power</b>		Turn the power supply switch on more than 12 hours before starting operation.
<b>1</b>		Press the SELECT button and select GROUP.
<b>2</b>		Select the ZONE No. including the group to be operated by pressing ZONE button.
<b>3</b>		Select the GROUP No. to be operated by pressing GROUP select buttons ◀ ▶.
<b>4</b>		Set the operation mode by pressing the MODE button.
<b>5</b>		Press the ON button.
<b>6</b>		Set the desired temperature by pressing one of the temperature setting buttons ▲ ▼.
<b>7</b>		Set the desired fan speed by pressing the FAN SPEED button.
<b>8</b>		Set the airflow direction to a specific angle or sweep mode.
<b>9</b>		By pressing , select your desired setting. Individual: → Controls with the remote controller are possible. Central 1: → Individual ON/OFF operation with the remote controller is inhibited. Central 2: → Individual ON/OFF, MODE, and Temp. setting operations with the remote controller are inhibited. Central 3: → Individual MODE and Temp. setting operations with the remote controller are inhibited. Central 4: → Individual MODE operation with the remote controller is inhibited. • Under Central/Individual settings other than listed above, "CENTRAL" is displayed.
<b>AUTO Operation</b>		Depending on the difference between the temperature setting and the room temperature, heating and cooling alternate automatically so that a uniform room temperature is maintained. Some models are not provided with a mode for automatically setting the cooling or heating operation.
<b>Stop</b>		Confirming the GROUP No. to be selected, press the OFF button.

**NOTE** The flap setting can be performed only for units that have no remote controllers.

## ■ How to start collective operation

To start collective operation (ALL or ZONE)

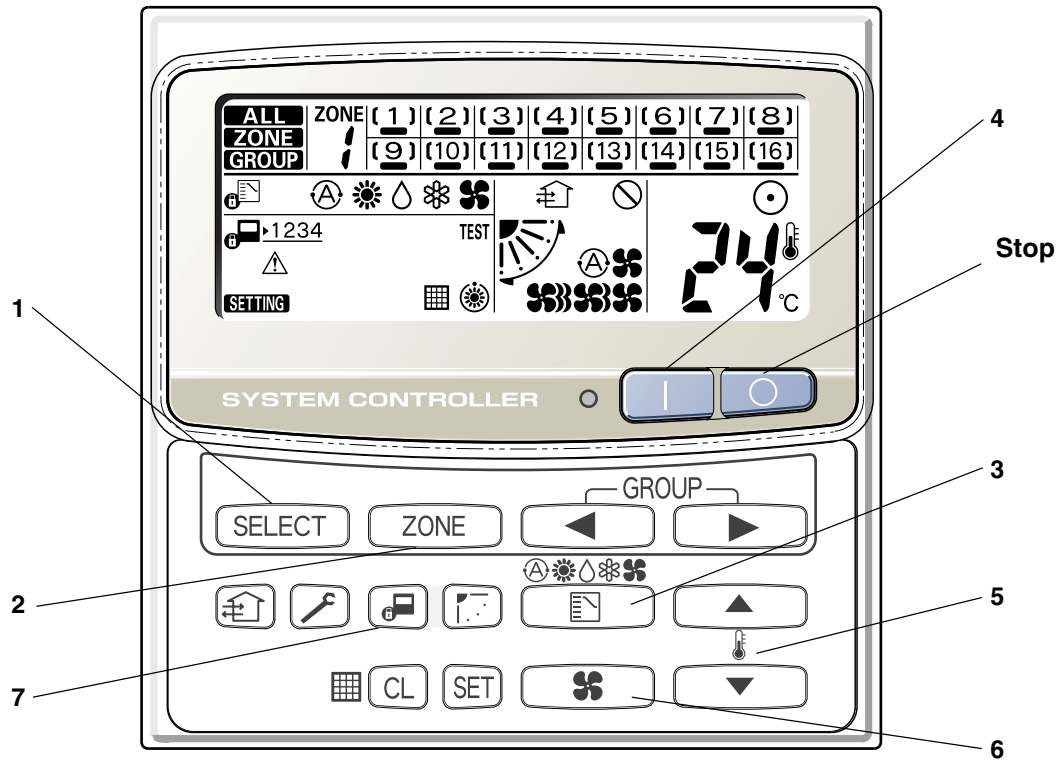

<b>Power</b>		Turn the power supply switch on 12 hours or more before starting operation.
<b>1</b>		Press the SELECT button and select ALL or ZONE. In case of ZONE collective operation.
<b>2</b>		Select the ZONE No. to be operated by pressing ZONE button.
<b>3</b>		Set the operation mode by pressing the MODE button.
<b>4</b>		Press the ON button.
<b>5</b>		Set the desired temperature by pressing one of the temperature setting buttons ▲ ▼.
<b>6</b>		Set the desired fan speed by pressing the FAN SPEED button.
<b>7</b>		Select the control mode.
<b>Stop</b>		Confirming the ZONE No. to be selected or ALL indication, press the OFF button.

**NOTE** In the ALL or ZONE mode, no flap setting can be performed. If necessary, you should select the GR mode and use the FLAP button.

**EG**

Save These Instructions!  
Conservez ces instructions!  
Bewahren Sie diese Anweisungen auf.  
Conservare questo manuale!  
Guarde estas instruções!  
Φυλάξτε αυτές τις οδηγίες!  
¡Guarde estas instrucciones!  
Bewaar deze gebruiksaanwijzing!  
请保存好本说明!

# TOSHIBA

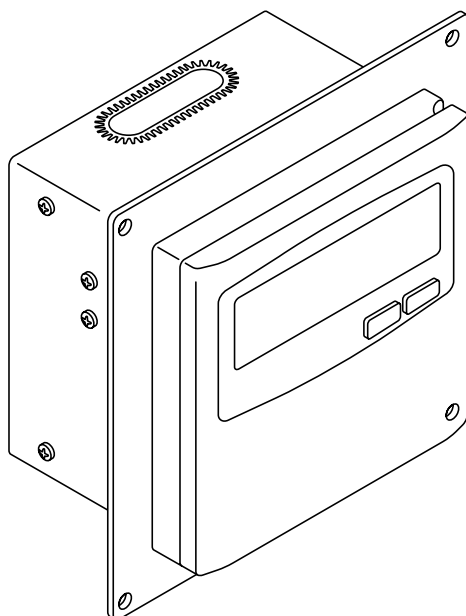

## TCB-SC642TLE

Central Remote Controller for Split System Air  
Conditioner

Télécommande centrale pour climatiseur à  
système deux blocs

Zentrale Fernbedienung für Klimagerät mit  
Splitbauweise

Centralina di controllo a distanza per  
condizionatore d'aria di tipo split

Controlador remoto central para aparelho de  
ar condicionado com sistema split

Κεντρικό τηλεχειριστήριο για διαχωρισμένο  
σύστημα κλιματισμού

Controlador remoto central para  
acondicionado de aire de sistema split

Centrale afstandsbediening voor dubbel-  
systeem airconditioner

分体系统空调机的中央遥控器

*INSTALLATION MANUAL*

*MANUEL D'INSTALLATION*

*INSTALLATIONSHANDBUCH*

*MANUALE DI INSTALLAZIONE*

*MANUAL DE INSTALAÇÃO*

*ΕΓΧΕΙΡΙΔΙΟ ΕΓΚΑΤΑΣΤΑΣΗΣ*

*MANUAL DE INSTALACIÓN*

*INSTALLATIEHANDLEIDING*

安装手册

**EG**

**F**

**D**

**I**

**P**

**GR**

**ES**

**NE**

**CS**

Pub. OI-85464359607000

TOSHIBA CARRIER CORPORATION

# Contents

	Page
Product Information.....	2
Alert Symbols.....	2
Installation Location .....	3
Electrical Requirements .....	3
Safety Instructions.....	3
1. General .....	4
2. Installation site selection .....	4
3. How to install the central controller .....	4
■ Overview of the central controller .....	5
■ Installation procedure .....	6
■ Layout of electrical terminals .....	7
■ How to wiring .....	8
4. Address switch setting .....	10
5. Mode setting .....	13
6. How to perform zone registration .....	14
■ ZONE registration table .....	15
(a) Zone registration using the remote controller (RBC-AMT21E).....	16
(b) Zone registration using the central controller (TCB-SC642TLE) .....	17
(c) Automatic zone registration using the central controller (TCB-SC642TLE) ...	18
7. Checking from the central controller for duplication of the central address ....	19
8. Connections with external equipment .....	20
9. Memory back up switch.....	20
10. Test run of the central controller.....	21
11. How to perform an air conditioner test run .....	21

## Product Information

If you have problems or questions concerning your Air Conditioner, you will need the following information. Model and serial numbers are on the nameplate on the bottom of the cabinet.

Model No. TCB-SC642TLE Serial No. \_\_\_\_\_

Date of purchase \_\_\_\_\_

Dealer's address \_\_\_\_\_

Phone number \_\_\_\_\_

### DECLARATION OF CONFORMITY

This product is marked « **CE** » as it satisfies EEC Directive No. 89/336/EEC, 73/23/EEC and 93/68/EEC.

This declaration will become void in case of misuse and/or from non observance though partial of Manufacturer's installation and/or operating instructions.

## Alert Symbols

The following symbols used in this manual, alert you to potentially dangerous conditions to users, service personnel or the appliance:



**WARNING**

This symbol refers to a hazard or unsafe practice which can result in severe personal injury or death.



**CAUTION**

This symbol refers to a hazard or unsafe practice which can result in personal injury or product or property damage.

## Installation Location

- We recommend that this central controller be installed properly by qualified installation technicians in accordance with the Installation Manual provided with the central controller.



### WARNING

- Do not install this central controller where there are fumes or flammable gases, or in an extremely humid space such as a greenhouse.
- Do not install the central controller where excessively high heat-generating objects are placed.

## Electrical Requirements

1. All wiring must conform to the local electrical codes. Consult your dealer or a qualified electrician for details.
2. Wiring must be done by a qualified electrician.



### CAUTION

To warm up the system, the power mains must be turned on at least 12 hours before operation. Leave the power mains ON unless you will not be using this appliance for an extended period.

Power mains

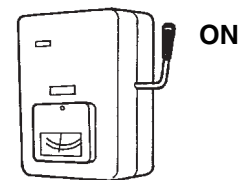

## Safety Instructions

- Read this booklet carefully before using this central controller. If you still have any difficulties or problems, consult your dealer for help.
- The air conditioner is designed to give you comfortable room conditions. Use this only for its intended purpose as described in the Owner's Manual.



### WARNING

- Never touch the unit with wet hands.
- Never use or store gasoline or other flammable vapor or liquid near the air conditioner — it is very dangerous.
- The air conditioner has no ventilator for intaking fresh air from outdoors. You must open doors or windows frequently when you use gas or oil heating appliances in the same room, which consume a lot of oxygen from the air. Otherwise there is a risk of suffocation in an extreme case.

EG







### CAUTION

- Do not turn the air conditioner on and off from the power mains switch. Use the ON/OFF operation button.
- Do not stick anything into the air outlet of the outdoor unit. This is dangerous because the fan is rotating at high speed.
- Do not let children play with the air conditioner.
- Do not cool or heat the room too much if babies or invalids are present.

## 1. General

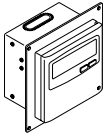
This booklet briefly outlines where and how to install the central controller. Please read over the entire set of instructions for the indoor and outdoor units and make sure all accessory parts listed are with the controller before beginning.

**NOTE** Give these instructions to the customer after finishing the installation.

Part Name	Figure	Q'ty	Remarks
Central controller		1	
Tapping screw	Truss-head Phillips 4 x 16 mm 	4	For securing the central controller
Rawl plug		4	For securing the central controller
Manual		1	For installation
		1	For operation

## 2. Installation site selection

- Install the central controller at a height of between 1 and 1.5 meters above the floor.
- Do not install the central controller in a place where it will be exposed to direct sunlight or near a window or other place where it will be exposed to the outside air.
- Be sure to install the central controller vertically, such as on a wall.

## 3. How to install the central controller



**CAUTION**

- Do not twist the control wiring together with the power wiring or run it through the same metal conduit, because this may cause a malfunction.
- Install the central controller away from sources of electrical noise.
- Install a noise filter or take other appropriate action if electrical noise affects the power supply circuit of the unit.



**WARNING**

Do not supply power to the unit or try to operate it until the tubing and wiring to the outdoor unit is completed.

■ Overview of the central controller

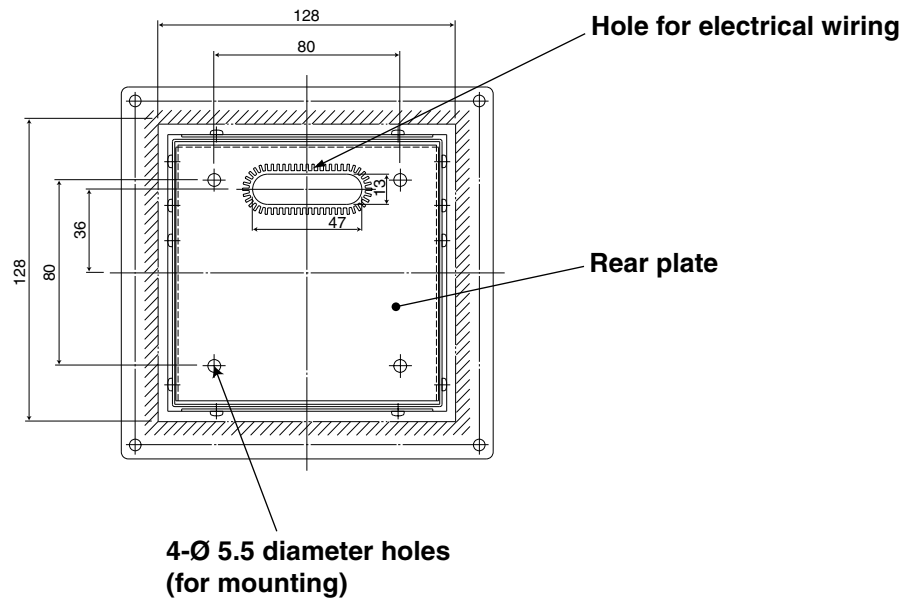
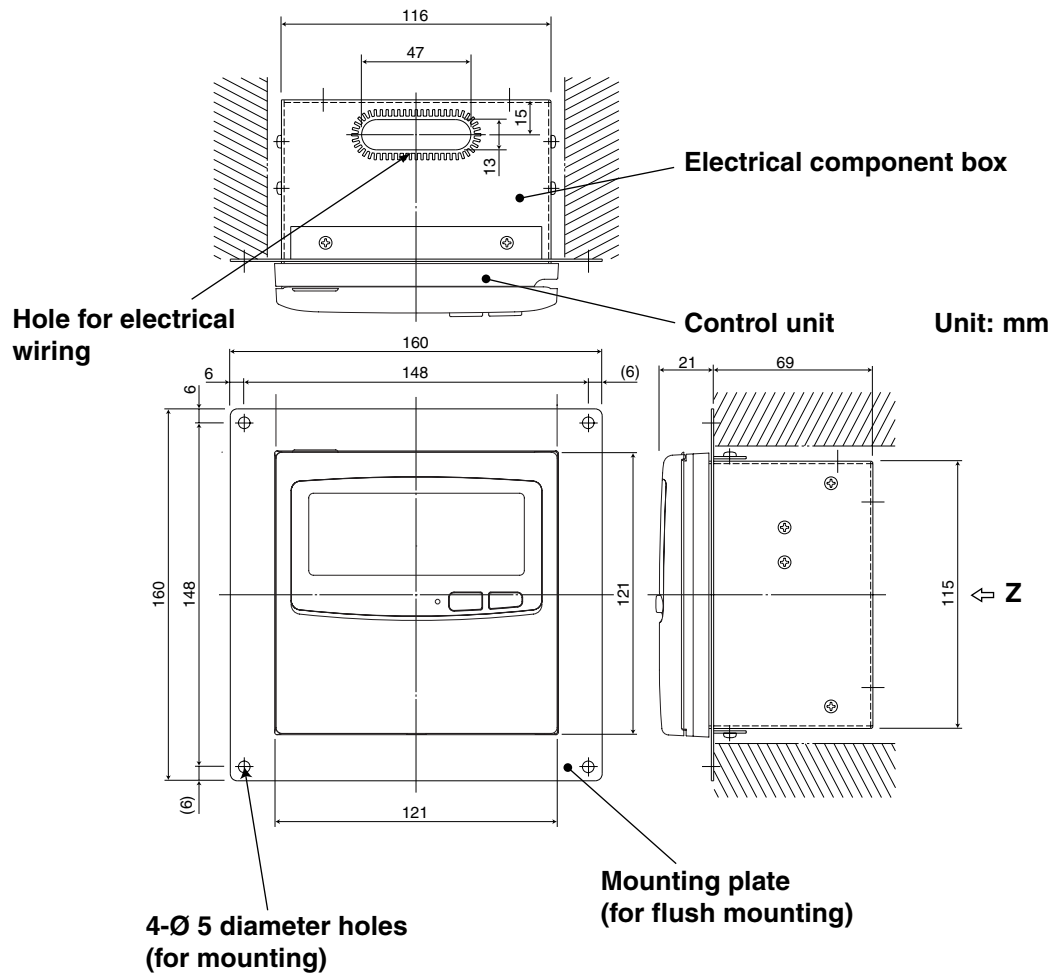
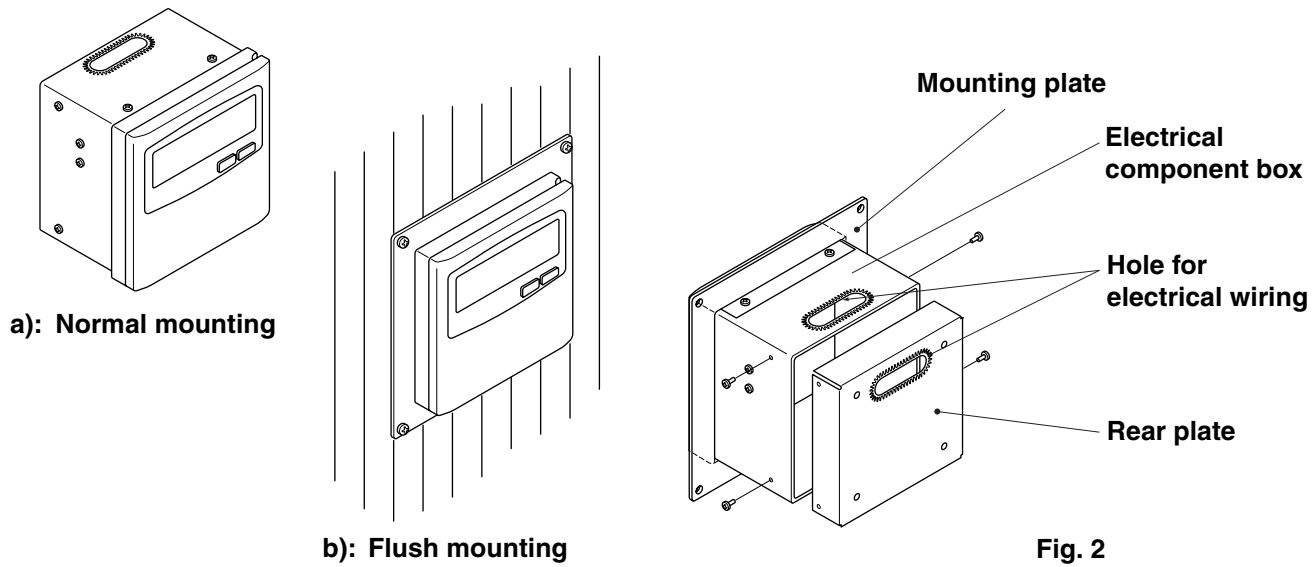

Fig. 1

\* In order to mount the central controller flush with the wall, an opening measuring 128 mm x 128 mm is necessary.

EG

## ■ Installation procedure



1. Decide how the central controller will be mounted: in the normal manner or flush with the wall.
  - a) To mount the central controller in the normal manner, remove the mounting plate. Then reattach the four screws to the electrical component box.
  - b) To mount the central controller flush with the wall, make an opening in the wall measuring 128 mm x 128 mm. The opening must be at least 85 mm deep as measured from the outside surface of the wall.
2. Remove the rear plate and connect the electrical wiring.
  - 1) Remove the four screws located on both sides of the rear plate.
  - 2) Either the hole in the top of the electrical component box or the hole in the rear plate may be used to feed the electrical wiring.
  - 3) If the hole on top is used, the rear plate should be turned upside down.
3. Secure the central controller in place.
  - a) If the central controller is being mounted in the normal manner, first attach the rear plate to the wall using the screws and Rawl plugs provided. Next, place the body of the central controller over the rear plate and secure it in place using four screws.
  - b) If the central controller is being mounted flush with the wall, fit it through the mounting plate on the wall and secure it in place using the screws and Rawl plugs provided.

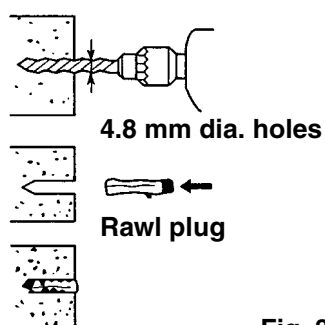

### NOTE

To mount the central controller on a wall made of cinder block, brick, concrete, or a similar material, drill 4.8 mm diameter holes in the wall and insert Rawl plugs to anchor the mounting screws.

■ Layout of electrical terminals

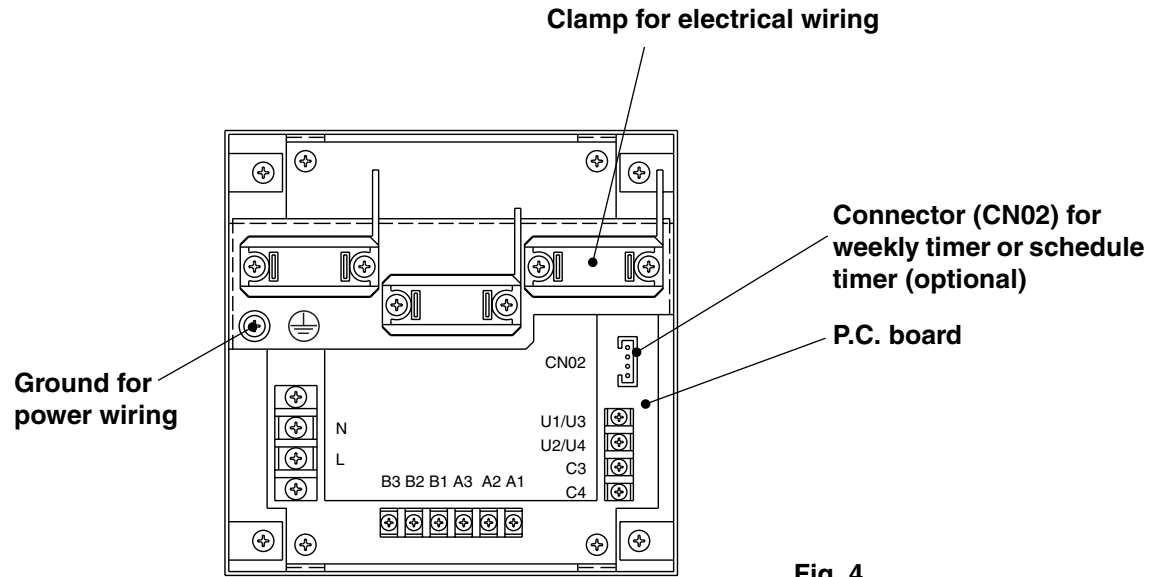

Fig. 4

**How to connect electrical wiring**

1) Basic wiring

- L:  Power supply ( $\sim$  50 Hz/60 Hz, 220–240 V)
- N:
- U1/U3:  Indoor unit control wiring. (Low voltage)
- U2/U4:
- C3: Auxiliary
- C4: Ground for inter-unit control wiring
- : Ground for power wiring

2) Terminals for remote monitoring

- A1: Input for turning on air conditioners concurrently.
- A2: Input for turning off air conditioners concurrently.
- A3: Common input for turning air conditioners on or off.
- B1: On operation state indicator output.
- B2: Alarm indicator output.
- B3: Common indicator output.

## ■ How to wiring



**CAUTION**

**Ensure that wiring connections are correct. (Incorrect wiring will damage the equipment.)**

### How to wire the central controller

In order to ensure safety, turn off the air conditioner power before mounting or removing the central controller.

- Connect the communication wires to the indoor/outdoor unit connecting wires or central control system wires.
- Use the following as the communication wires.  
Total wire length of less than 1,000 meters: MVVS1.25mm<sup>2</sup>  
Total wire length of less than 2,000 meters: MVVS2.0mm<sup>2</sup>  
The total wire length is obtained by adding the lengths of the indoor/outdoor unit connecting wires to the lengths of the central control system wires.
- Do not run the communication wires inside the same electrical wire conduits as the power cables, connect them using similar wires or allow them to be routed near other wires.
- For the communication wires, use signal wires that visually identify them as being different from either the remote controller wires or the power cables.
- Connect the power cable of the central controller to the AC220–240V power source. (Incorrect wiring will damage the equipment.)
- Connect the wires in such a way that none of the wires will be connected incorrectly. (Incorrect wiring will damage the equipment.)

### <Basic wiring diagram>

Connect the communication wires of the air conditioners shown which is the wiring employed when using central control is used.

- The maximum number of air conditioners which can be connected in one central control system is 64 indoor units and 16 outdoor units (center units). (With Super Modular Multi system)
- Up to ten central controllers including other central control units can be connected.

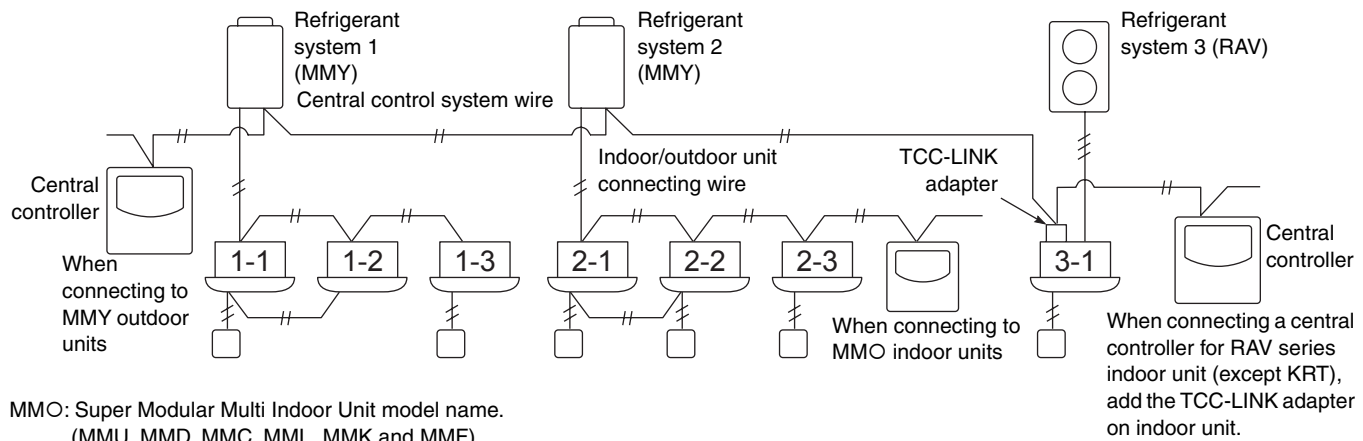

**Fig. 5**

**NOTE**

- When connecting to MMY outdoor units, make the connection to the central control system wires (U3 and U4 terminals).
- When connecting to MMO indoor units, make the connection to the indoor/outdoor unit connecting wire (U1 and U2 terminals).
- When connecting to a RAV air conditioner, make the connection to the U3 and U4 terminals of the TCC-LINK.
- The TCC-LINK adapter is required for the RAV air conditioner. (except KRT series.)
- A general-purpose unit control interface is required with some air conditioner models.

<Wiring connection procedure>

As shown in the figure below, connect the terminal block (U1/U3, U2/U4) of the central controller with the terminals (U3, U4) of the outdoor unit (central unit).

- It is also possible to connect to the indoor/outdoor unit connecting wire terminals (U1, U2) of the indoor or outdoor unit (no matter which refrigerant system is used).
- Since the terminals do not have polarities, U1/U2 or U3/U4 can be reversed.

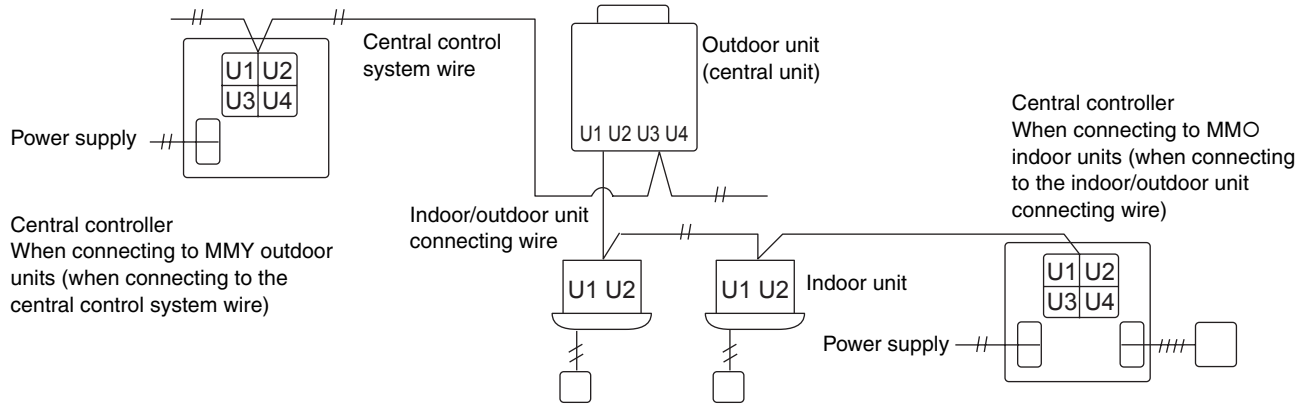

Fig. 6

**NOTE**

The fuse will blow to protect the equipment if an AC voltage of 220–240V is applied by mistake to U1/U3 or U2/U4. If this should happen, first re-connect the terminals properly, and then connect the communication wire to the U1/U3 and spare terminals. Check the fuse on the indoor/outdoor control board since this fuse may have blown as well.

<Grounding the shielded wires>

- Terminate the connection of the shielded wires for all the central control wires, and provide single-point grounding.
- Even when connecting the centrally controlled unit to the indoor/outdoor unit connecting wires, terminate the connection of the shielded wires, and provide single-point grounding for all the indoor/outdoor unit connecting wires.
- Leave the final termination open (insulate it).

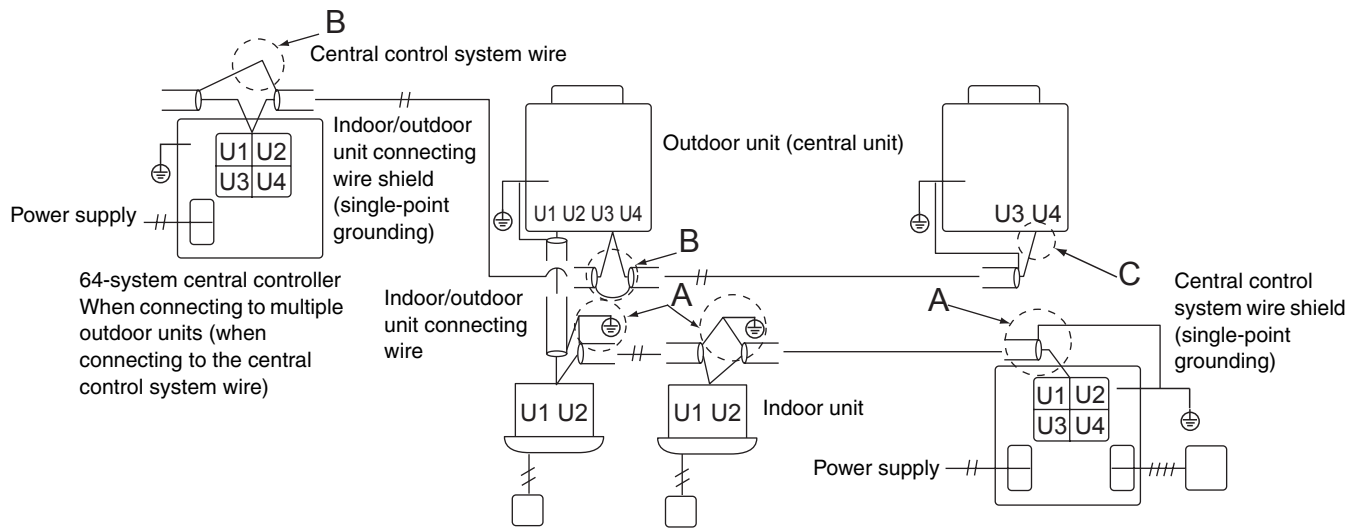

Area A: Ground both ends of the shielded cable used for the indoor/outdoor unit connection.  
 Area B: Connect a shielded cable for the central control system wiring.  
 Area C: Ground only one end of the central control system wiring at its final termination. (Leave the other end of the wire at its final termination as an open wire (i.e. insulate it).)

64-system central controller  
 When connecting to multiple indoor units (when connecting to the indoor/outdoor unit connecting wire)

Fig. 7

**EG**

## 4. Address switch setting

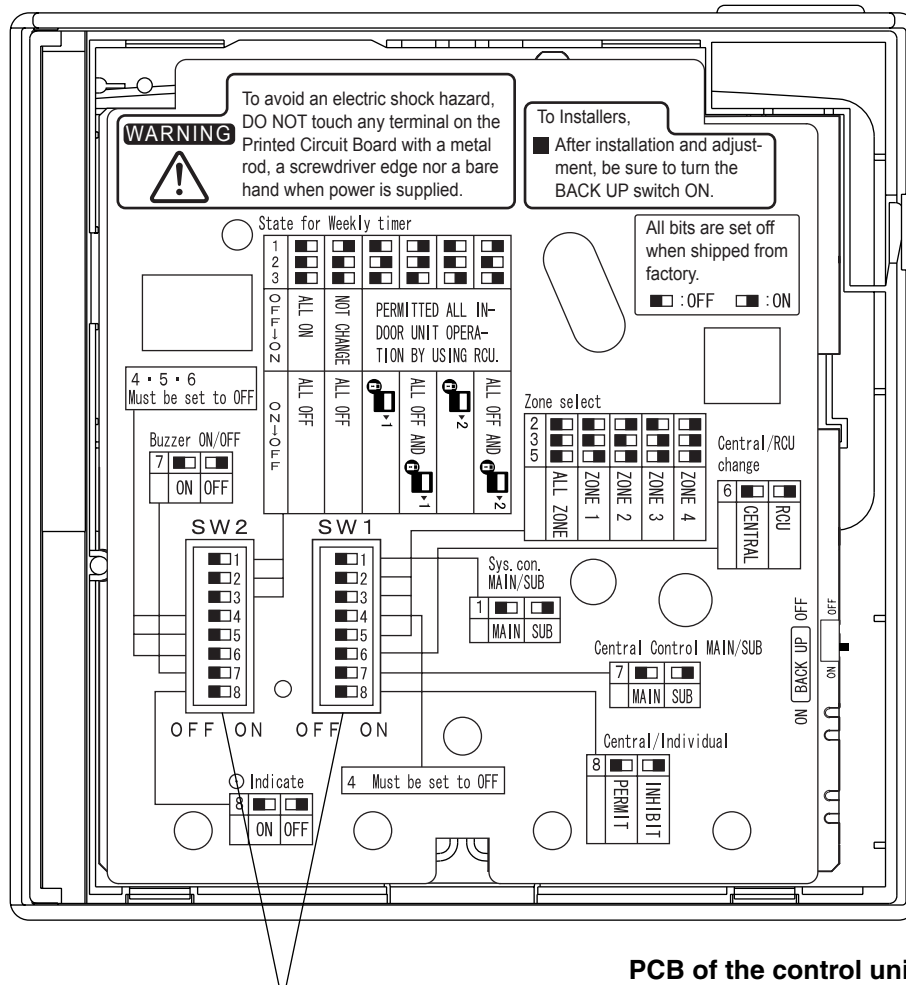

Dip switch

Fig. 8

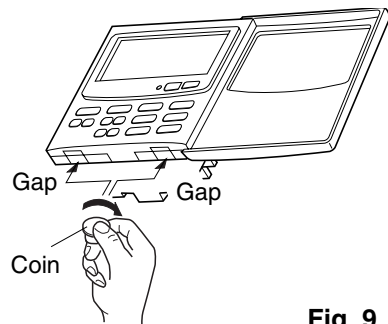
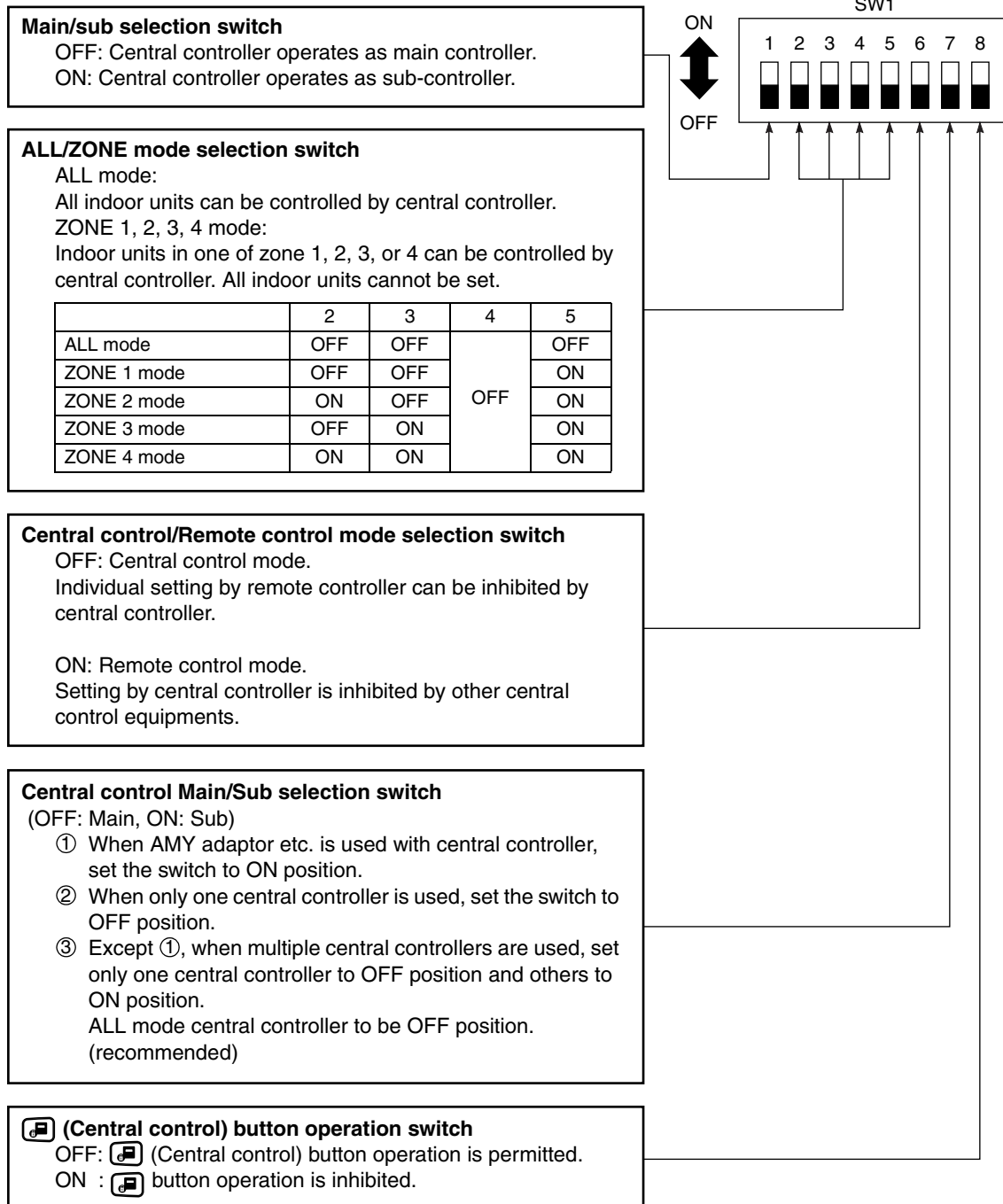

Fig. 9

### How to reach the P.C. board

Remove the flat-top screw on the bottom of the back case. When you open up the decorative cover, you will see two notches under the control unit. Inset a coin or other flat object into these notches and pry off the back case. The P.C. board on the back of the control unit is now visible.

**SW1**



\*All switches are OFF position at shipment.

**Fig. 10**

**EG**

**SW2**

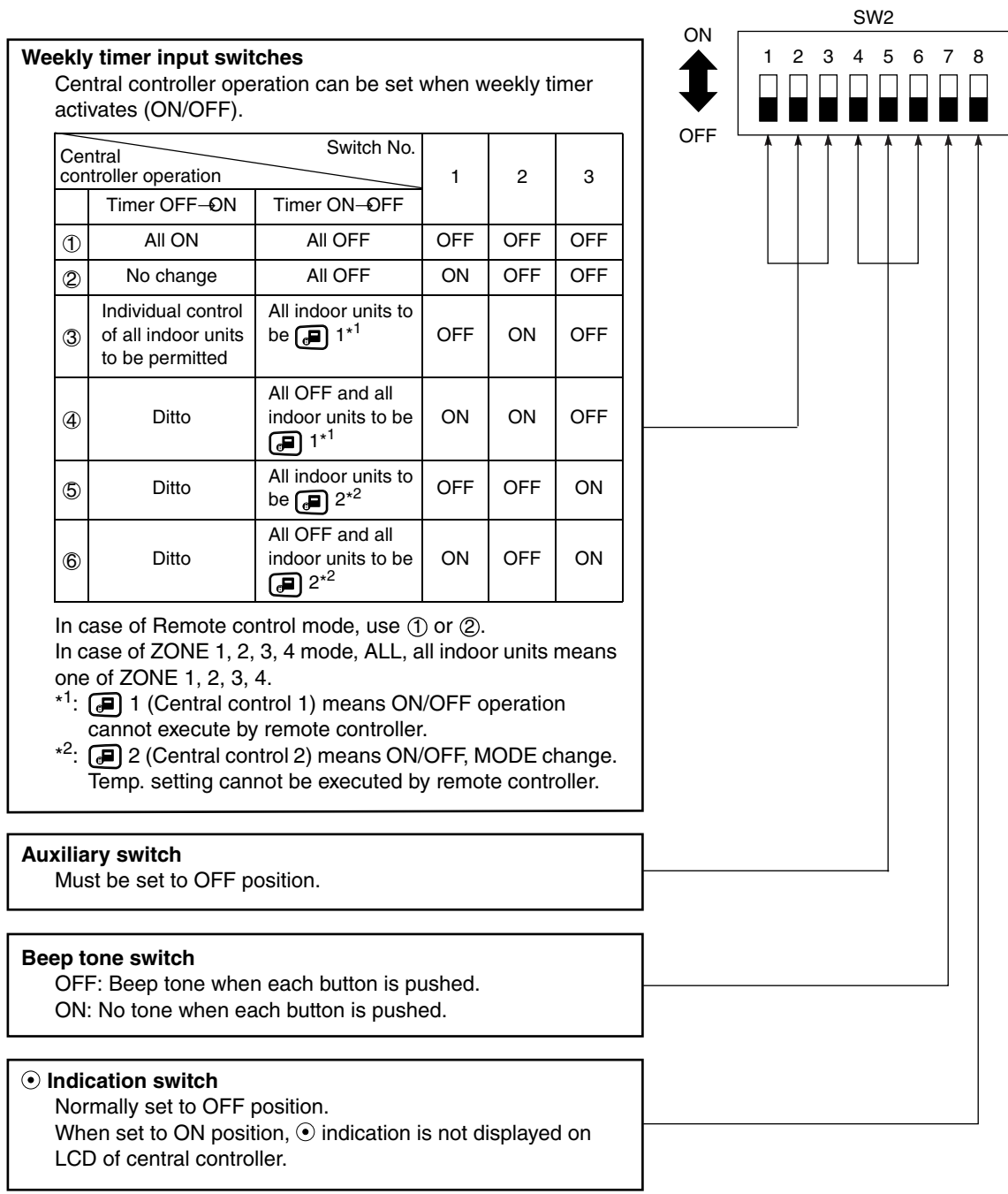

\*All switches are OFF position at shipment.

**Fig. 11**

## 5. Mode setting

According to function of each central controller, set SW1 as Fig. 12.

(1) Central control/Remote control mode

● Central control mode

Central controller is used as central control equipment.  
Individual setting by remote controller can be inhibited by central controller.

● Remote control mode

Central controller is used as remote controller.  
Setting by central controller is inhibited by other central control equipments.

(2) ALL/ZONE mode

● ALL mode

All indoor units can be controlled by central controller.

● ZONE mode

Indoor units in one of ZONE 1, 2, 3 or 4 can be controlled by central controller.

(3) Function of central controller is 10 types according to combination of central control/remote control mode and ALL/ZONE mode setting as the table 1.

(4) Stick the central controller unit label in a conspicuous position.

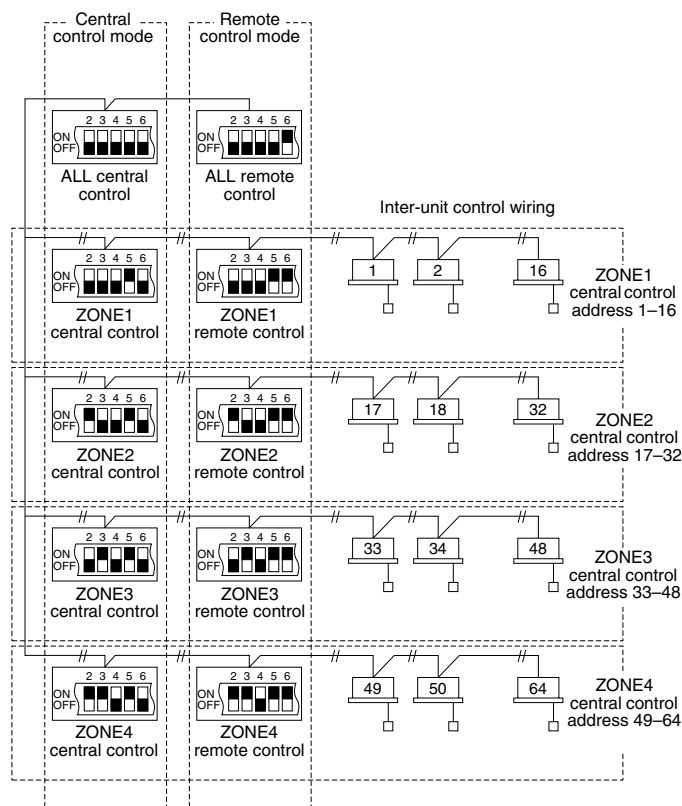

Fig. 12

Table 1

	Central control	Remote control
ALL	1. ALL/Central	6. ALL/Remote
ZONE1	2. ZONE1/Central	7. ZONE1/Remote
ZONE2	3. ZONE2/Central	8. ZONE2/Remote
ZONE3	4. ZONE3/Central	9. ZONE3/Remote
ZONE4	5. ZONE4/Central	10. ZONE4/Remote



## 6. How to perform zone registration

To operate the central controller properly, zone registration is required after finishing the test run (and after setting all indoor unit addresses) using one of the following methods.

### Procedures common to all units

1. Connect the U1/U2 terminals to the relay connectors of the U3/U4 terminals inside the outdoor unit (central unit).
2. Leave the SW30-2 switch on the outdoor unit (central unit) interface board at the ON position for one system only, and set all the other switches to OFF. (For details on the SW-30 position, refer to the wiring diagram provided with the outdoor unit.)
  - (a) Zone registration using the remote controller (RBC-AMT21E)  
Refer to page 16
  - (b) Zone registration using the central controller (TCB-SC642TLE)  
Refer to page 17
  - (c) Automatic zone registration using the central controller (TCB-SC642TLE)  
Refer to page 18

For methods (a) and (b), you should make a zone registration table manually before performing the registration as shown on the page 15.

For method (c), zone registration is executed automatically, proceeding from small indoor unit address and small central addresses to larger numbers in numerical order. For example:

### For methods (b) and (c)

These methods are not supported by the RAV models.

For RAV models, initiate the zone registration described in (a).

Wait at least 10 minutes after the power has been turned on before starting to set the addresses.

It may take up to 10 minutes (although it usually takes 3 minutes) to establish initial communication between the indoor and outdoor units. If the addresses are set before this communication is completed, the central address may fail to be set in some of the indoor units.

Central address	1	2	3	4	5	6	
ZONE-group	1-1	1-2	1-3	1-4	1-5	1-6	
Indoor unit address	1-1	1-2	2-1	2-2	2-3	3-1	

### NOTE

1. An indoor unit address is assigned to each indoor unit during automatic address operation. Each indoor unit address combines an R.C. address and indoor unit number as follows:

1-1 : Indoor unit address (UNIT No.)  
   ↑    ↑  
   R.C. address Indoor unit No.

This address is displayed on remote controller for UNIT No. when the UNIT button is pressed.

2. The central address represents the zone and group number. These addresses are assigned in ascending numerical order.
3. For details on how to set the addresses when the TCC-LINK adapter is connected for central control, refer to these instructions and to the installation instructions of the TCC-LINK adapter.

■ ZONE registration table

ZONE	GROUP	Central address	Indoor unit address (UNIT No.)	Unit location	ZONE	GROUP	Central address	Indoor unit address (UNIT No.)	Unit location
1	1	1			3	1	33		
	2	2				2	34		
	3	3				3	35		
	4	4				4	36		
	5	5				5	37		
	6	6				6	38		
	7	7				7	39		
	8	8				8	40		
	9	9				9	41		
	10	10				10	42		
	11	11				11	43		
	12	12				12	44		
	13	13				13	45		
	14	14				14	46		
	15	15				15	47		
	16	16				16	48		
2	1	17			4	1	49		
	2	18				2	50		
	3	19				3	51		
	4	20				4	52		
	5	21				5	53		
	6	22				6	54		
	7	23				7	55		
	8	24				8	56		
	9	25				9	57		
	10	26				10	58		
	11	27				11	59		
	12	28				12	60		
	13	29				13	61		
	14	30				14	62		
	15	31				15	63		
	16	32				16	64		

**EG**

**NOTE**

1. Assign indoor unit addresses to the desired positions (central addresses) manually.
2. For group control, only the main indoor unit should be assigned. Sub indoor units cannot be assigned.

**(a) Zone registration using the remote controller (RBC-AMT21E)**





(Determination of central address)

This method is not supported by the RAV models. For RAV models, initiate the zone registration described in (a).

- In this case, after confirming which indoor unit is connected to the remote controller and that the air conditioner in the OFF state, you set the central addresses one at a time.
- If the system has no remote controller, connect a remote controller to the system temporarily. Then follow this procedure.



**NOTE**

The indoor unit address must already have been set before performing zone registration. If necessary, refer to the Installation Manual supplied with the outdoor unit.

- (1) Press the  and  buttons at the same time of the remote controller for more than 4 seconds.
- (2) Do not press  button.
- (3) Once in this mode, the UNIT No., CODE No., No. of SET DATA and  indications will flash on the display as shown Fig. 13.







**NOTE**

In case of group control "ALL" instead of "UNIT No." will flash on the display. Select the main indoor unit address by pressing the  button once.

- (4) Set CODE No. to 03 using the  and  (  ) buttons.

**NOTE**

The CODE No. 03 must be selected to perform zone registration using the remote controller.

- (5) Set the Central address which you want to assign to the indoor unit address using the  and  (  ) buttons according to the zone registration table.
- (6) Press the  button. The CODE No. and Central address changes from flashing to ON state. If you make mistake, then press the  button and reset the central address.
- (7) Press the  button to finish zone registration.

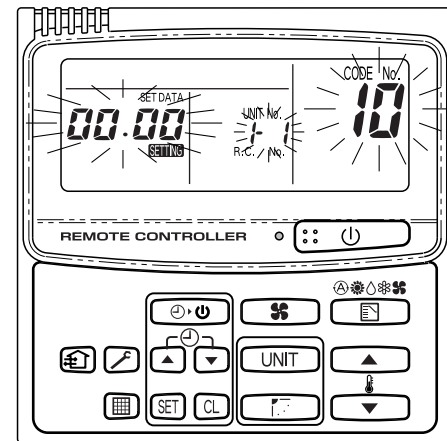
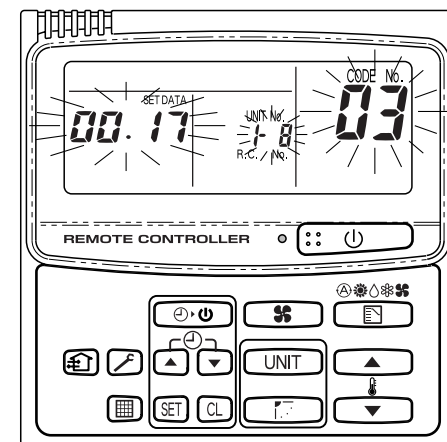
**Fig. 13**

For example, in this case  
 Indoor unit address: 1-8  
 Central address: 17 (ZONE 2, GROUP 1)

**Fig. 14**

**(b) Zone registration using the central controller (TCB-SC642TLE)**

This method is not supported by the RAV models.  
For RAV models, initiate the zone registration described in (a).

- In this case, you set all Central addresses by central controller at once manually.

(1) Press the **SETTING** and **ZONE** buttons at the same time for more than 4 seconds.

**SETTING** and CODE No. C1 will flash.

(2) After confirming that CODE No. C1 is displayed, press the **SET** button. Once in this mode, a change takes place as Fig. 15.

(3) Select the zone and group No. which you want to set with **ZONE** and **GROUP** buttons. If already set, press the **CL** buttons.

(4) Set the unit No. (Indoor unit address) with **CL** and **SETTING** buttons, according to the zone registration table.

R.C. No. .... **SETTING** button

Indoor unit No..... **SETTING** button

(5) Press the **SET** button.

GROUP No. turns ON and UNIT No. (Indoor unit address) changes from flashing to ON state. UNIT No. is registered to selected ZONE No. and GROUP No.

If you make mistake, then press the **CL** button and reselect the ZONE, GROUP and UNIT No.

(6) Register the other UNIT No. in the same way by following the steps (3) to (5).

(7) Finally, complete the registration by pressing the **SETTING** button.

**SETTING** flashes for a few minutes, then OFF.

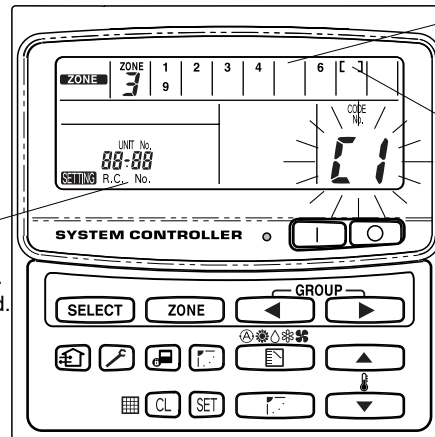

If no data is registered no number is displayed.  
Selected group No. if no data is registered.

If data is registered the unit No. is displayed.

**Fig. 15**

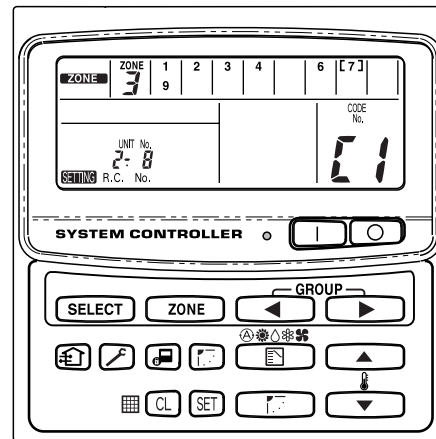











For example, in the case at left  
Zone 3, group No. 7  
Unit No. (indoor unit address) 2-8

Unit No. 2-8 is registered to zone 3-group 7.

**Fig. 16**



### (c) Automatic zone registration using the central controller (TCB-SC642TLE)

- (1) Press the  and  buttons at the same time for more than 4 seconds.  
 and CODE No. C1 will flash.
- (2) Select CODE No. C2 by pressing  and  (  ) button and press the  button.  
 C2 changes from flashing to ON state and automatic zone registration will start.
- (3) Registered GROUP No. will be disappeared all.
- (4) Central address will be assigned from small indoor unit address to large one in numerical order automatically.  
 Finishing automatic zone registration,  changes from flashing to OFF.
- (5) If the error is happened, the "CHECK" starts flashing and zone registration finishes at this time. Press the  button.
- (6) Finally, complete automatic zone registration mode by pressing the  button.  
 flashes for a few minutes, then OFF.

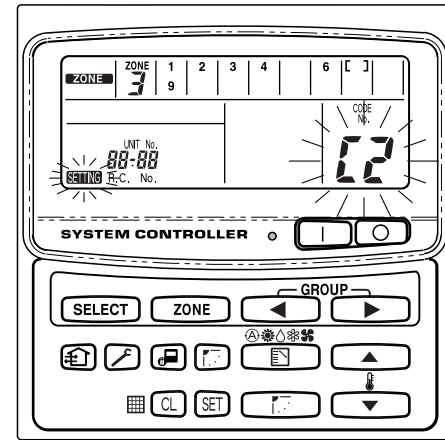

















Fig. 17

## 7. Checking from the central controller for duplication of the central address

### Central address duplication error check: C3

\* This cannot be used with RAV air conditioners. For further details, refer to the instructions of the TCC-LINK adapter.

- (1) Hold down the  and  buttons together for at least four seconds. (CODE No. C1 starts flashing.)
- (2) Press the  or  (  ) button to select CODE No. C3.
- (3) When the  button is now pressed, CODE No. C3 lights and  flashes. The central address duplicated error check now starts.
- (4) The addresses of all the indoor units is checked in sequence starting with outdoor unit system 1. The check is completed when CODE No. C3 flashes and  goes off.
- (5) If any duplication is discovered among the central addresses, the GROUP No. will flash.  
Press the  or  (  ) button to select CODE No. C1, and press the  button.  
The central address is cleared by selecting the area where the GROUP No. is flashing and by pressing the  button. Set the correct central address using the wired remote controller or the central controller.
- (6) Press the  button to complete the procedure.  
 flashes for several minutes, the initial setting is automatically established, and the procedure is completed.

### 8. Connections with external equipment

Designation	Input/output item	Central controller side		Equipment side		
		Input/output conditions	Terminal name	Demarcation terminals	Circuitry example	Input/output conditions
Digital input/output terminals	Status output	Operate output Alarm output "A" (normally open) contact without voltage Static (relay output) Allowable contact voltage, current: DC 30 V, 0.5 A	Operate Alarm Output common	CPEV 0.9 to 1.2φ		Wiring length: Max. 100 meters
	Control input	All operate input All stop input "A" (normally open) contact with voltage Pulse (photocoupler input) Allowable contact voltage, current: DC 24 V, 10 mA	All operate (+) All stop (+) Input common (-)	CPEV 0.9 to 1.2φ		Pulse width: 300 ms or more Wiring length: Less than 100 meters

### 9. Memory back up switch

Check the back up switch is ON for back side of central controller PCB.

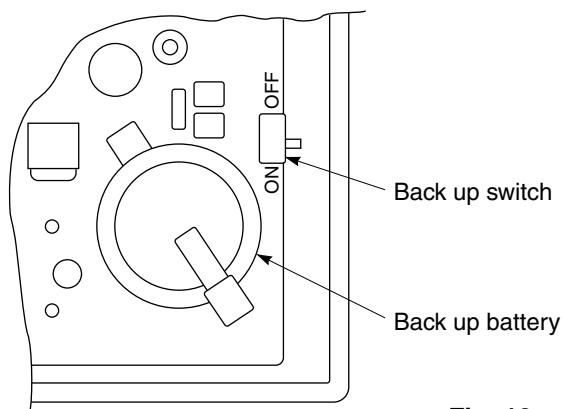





Fig. 18

## 10. Test run of the central controller

- (1) Power on for all indoor units. Next, power on for central controller.  
    **SETTING** will flash, checking the indoor unit address automatically.
- (2) If group No. displayed on central controller is not same as indoor unit No.\* which is connected, see Fig. 7 and setting again.

\*In case of group control, main unit No. only.

## 11. How to perform an air conditioner test run

- (1) Hold down the  button of the central controller for at least four seconds.
  - During the test run, "TEST" appears on the LCD display.
- (2) Press the  and  buttons.
  - The temperature cannot be adjusted at the "TEST" position.  
Do not use this procedure except when performing a test run since it will strain the equipment.
- (3) Upon completion of the operation, press the  button, and check that "TEST" on the LCD display has gone off.