

# TOSHIBA

INSTALLATION MANUAL  
MANUEL D'INSTALLATION  
INSTALLATIONS-HANDBUCH  
MANUALE D'INSTALLAZIONE  
MANUAL DE INSTALACIÓN  
MANUAL DE INSTALAÇÃO  
INSTALLATIEHANDLEIDING  
ΕΓΧΕΙΡΙΔΙΟ ΕΓΚΑΤΑΣΤΑΣΗΣ

AIR CONDITIONER (SPLIT TYPE)  
CLIMATISEUR (TYPE SPLIT)  
KLIMAGERÄT (SPLIT-TYP)  
CONDIZIONATORE D'ARIA (TIPO SPLIT)  
AIRE ACONDICIONADO (TIPO SPLIT)  
AR CONDICIONADO (TIPO SPLIT)  
AIRCONDITIONER (GESPLITST TYPE)  
ΚΛΙΜΑΤΙΣΤΙΚΟ (ΤΥΠΟΣ SPLIT)

<Under Ceiling Type> / <Type sous le plafond>  
<Zwischendeckentyp> / <Tipo sotto il soffitto>  
<Modelo de techo> / <Tipo Sob o Tecto>  
<Type voor montage boven verlaagd plafond> / <Τύπος κάτω από την οροφή>

Heat Pump Model/Modèle à thermopompe  
Geräte mit Heizung/Modello con pompa di riscaldamento  
Modelo con bomba de calor/Modelo de bomba térmica  
Model met warmtepomp/Μοντέλο με Αντλία Θερμότητας



Indoor Unit/Unité intérieure  
Raumeinheit/Unità interna  
Unidad interior/Unidade interior  
Binneneinheit/Εσωτερική μονάδα

Outdoor Unit/Unité extérieure  
Außengerät/Unità esterna  
Unidad exterior/Unidade exterior  
Buiteneunit/Εξωτερική μονάδα

**RAV-SM562CT-E**  
**RAV-SM802CT-E**  
**RAV-SM1102CT-E**  
**RAV-SM1402CT-E**

**RAV-SM562AT-E**  
**RAV-SM802AT-E**  
**RAV-SM1102AT-E**  
**RAV-SM1402AT-E**

**SP562AT-E**  
**SP802AT-E**  
**SP1102AT-E**  
**SP1402AT-E**

Please read this Installation Manual carefully before installing the Air Conditioner.

- This Manual describes the installation method of the indoor unit.
- For installation of the outdoor unit, follow the Installation Manual attached to the outdoor unit.

Veillez lire attentivement ce Manuel d'installation avant d'installer le climatiseur.

- Ce manuel décrit la procédure d'installation de l'unité intérieure.
- Pour installer l'unité extérieure, reportez-vous au Manuel d'installation fourni avec l'unité extérieure.

Bitte lesen Sie dieses Handbuch sorgfältig, bevor Sie mit der Installation des Klimagerätes beginnen.

- In diesem Handbuch wird die Installation der Raumeinheit beschrieben.
- Um die Außeneinheit zu installieren, folgen Sie den Anweisungen in dem Handbuch, das der Außeneinheit beiliegt.

Prima di installare il condizionatore d'aria, leggere con attenzione questo manuale d'installazione.

- Questo manuale descrive il metodo d'installazione dell'unità interna.
- Per l'installazione dell'unità esterna, fare riferimento al manuale d'installazione fornito insieme all'unità esterna.

Lea atentamente este Manual de instalación antes de proceder a la instalación del aparato de aire acondicionado.

- Este manual describe el método de instalación de la unidad interior.
- Para la instalación de la unidad exterior, consulte el Manual de instalación que acompaña a la unidad exterior.

Leia atentamente o presente Manual de Instalação antes de instalar o Ar Condicionado.

- O presente manual descreve o método de instalar a unidade interior.
- Para a instalação de uma unidade exterior, siga o Manual de Instalação que acompanha a unidade exterior.

Lees deze installatiehandleiding zorgvuldig door voordat u de airconditioner gaat installeren.

- Deze installatiemethode beschrijft de installatiemethode van de binneneunit.
- Zie voor de installatie van de buiteneunit, de installatiehandleiding bij de buiteneunit.

Παρακαλώ διαβάστε προσεκτικά το Εγχειρίδιο Εγκατάστασης πριν από την εγκατάσταση του Κλιματιστικού.

- Το παρόν Εγχειρίδιο περιγράφει τη μέθοδο εγκατάστασης της εσωτερικής μονάδας.
- Για την εγκατάσταση της εξωτερικής μονάδας, ακολουθήστε το Εγχειρίδιο Εγκατάστασης που συνοδεύει την

## **ADOPTION OF NEW REFRIGERANT**

This Air Conditioner is a new type which adopts a new refrigerant HFC (R410A) instead of the conventional refrigerant R22 in order to prevent destruction of the ozone layer.

---

## **UTILISATION DU NOUVEAU REFRIGERANT**

Ce climatiseur est d'un type inédit qui utilise le nouveau réfrigérant HFC (R410A) au lieu du réfrigérant traditionnel R22, afin d'éviter la destruction de la couche d'ozone.

---

## **EINFÜHRUNG EINES NEUEN KÜHLMITTELS**

Dies ist ein neuartiges Klimagerät. Anstatt des herkömmlichen Kühlmittels R22 verwendet es das neue ozonschichtschonende HFC Kühlmittel R410A.

---

## **ADOZIONE DI UN NUOVO REFRIGERANTE**

Questo condizionatore d'aria è di un tipo nuovo che adotta un nuovo refrigerante HFC (R410A) al posto del refrigerante convenzionale R22, per prevenire la distruzione dello strato di ozono dell'atmosfera terrestre.

---

## **ADOPCIÓN DE NUEVO REFRIGERANTE**

Este aparato de aire acondicionado es un modelo reciente que incorpora el nuevo refrigerante HFC (R410A) en lugar del refrigerante convencional R22 para así evitar daños en la capa de ozono.

---

## **ADOPÇÃO DO NOVO REFRIGERANTE**

Este ar condicionado é um modelo novo que adota um novo refrigerante HFC (R410A) em vez do refrigerante convencional R22 para evitar a destruição da camada de ozono.

---

## **TOEPASSING VAN EEN NIEUW KOELMIDDEL**

Deze airconditioner is een nieuwe type dat werkt met een nieuw koelmiddel HFC (R410A) in plaats van met het conventionele koelmiddel R22, als bijdrage om de aantasting van de ozonlaag te reduceren.

---

## **ΥΙΟΘΕΤΗΣΗ ΝΕΟΥ ΨΥΚΤΙΚΟΥ**

Το παρόν Κλιματιστικό είναι νέος τύπος που υιοθετεί νέο ψυκτικό HFC (R410A) στη θέση του συμβατικού ψυκτικού R22 προκειμένου να βοηθήσει στην προστασία του όζοντος.

## CONTENTS

Accessory parts and Parts to be procured locally ..... 1	<b>6</b> TEST RUN ..... 16
<b>1</b> PRECAUTIONS FOR SAFETY ..... 2	<b>7</b> TROUBLESHOOTING ..... 18
<b>2</b> SELECTION OF INSTALLATION PLACE ..... 4	<b>8</b> APPLICABLE CONTROLS ..... 19
<b>3</b> DRAIN PIPING WORK ..... 9	<b>9</b> INSTALLATION/SERVICING TOOLS ..... 25
<b>4</b> REFRIGERANT PIPING AND EVACUATING ..... 11	<b>10</b> MAINTENANCE ..... 25
<b>5</b> ELECTRICAL WORK ..... 13	

## SOMMAIRE

Pièces accessoires et pièces non fournies ..... 27	<b>6</b> ESSAI DE FONCTIONNEMENT ..... 42
<b>1</b> MESURES DE SECURITE ..... 28	<b>7</b> DEPANNAGE ..... 44
<b>2</b> SELECTION DU LIEU D'INSTALLATION ..... 30	<b>8</b> COMMANDES UTILISABLES ..... 45
<b>3</b> INSTALLATION DES TUYAUX D'EVACUATION ..... 35	<b>9</b> OUTILS D'INSTALLATION/D'ENTRETIEN ..... 51
<b>4</b> TUYAUTERIE DE FRIGORIGÈNE ET ÉVACUATION ..... 37	<b>10</b> ENTRETIEN ..... 51
<b>5</b> INSTALLATION ELECTRIQUE ..... 39	

## INHALT

Zubehör und bauseits bereitzustellende Teile ..... 53	<b>6</b> TESTLAUF ..... 68
<b>1</b> SICHERHEITSVORKEHRUNGEN ..... 54	<b>7</b> FEHLERBESEITIGUNG ..... 70
<b>2</b> AUSWAHL DES AUFSTELLUNGORTES ..... 56	<b>8</b> STEUERUNGSMÖGLICHKEITEN ..... 71
<b>3</b> INSTALLATION DES ABLAUFROHRS ..... 61	<b>9</b> INSTALLATIONS/WARTUNGSWERKZEUGE ..... 77
<b>4</b> KÜHLMITTELLEITUNGSSYSTEM UND ENTLÜFTUNG ..... 63	<b>10</b> WARTUNG ..... 77
<b>5</b> ELEKTROINSTALLATION ..... 65	

## INDICE

Accessori e parti da acquistare sul posto ..... 79	<b>6</b> FUNZIONAMENTO DI PROVA ..... 94
<b>1</b> PRECAUZIONI PER LA SICUREZZA ..... 80	<b>7</b> GUIDA PER I PROBLEMI DI FUNZIONAMENTO ..... 96
<b>2</b> SCELTA DEL POSTO D'INSTALLAZIONE ..... 82	<b>8</b> COMANDI APPLICABILI ..... 97
<b>3</b> LAVORO PER TUBAZIONE DI SCARICO ..... 87	<b>9</b> ATTREZZI PER INSTALLAZIONE/ ASSISTENZA TECNICA ..... 103
<b>4</b> TUBAZIONI DEL REFRIGERANTE E SCARICO ..... 89	<b>10</b> MANUTENZIONE ..... 103
<b>5</b> ESECUZIONE DEI COLLEGAMENTI ELETTRICI ..... 91	

## CONTENIDO

Componentes accesorios y componentes de obtención local . 105	<b>6</b> PRUEBA DE FUNCIONAMIENTO ..... 120
<b>1</b> PRECAUCIONES PARA SU SEGURIDAD ..... 106	<b>7</b> SOLUCIÓN DE PROBLEMAS ..... 122
<b>2</b> SELECCIÓN DEL LUGAR DE INSTALACIÓN ..... 108	<b>8</b> CONTROLES APLICABLES ..... 123
<b>3</b> TRABAJOS DE CANALIZACIÓN DE DESAGÜE ..... 113	<b>9</b> HERRAMIENTAS DE INSTALACIÓN Y REPARACIÓN ... 129
<b>4</b> TUBOS DE REFRIGERANTE Y EVACUACIÓN ..... 115	<b>10</b> MANTENIMIENTO ..... 129
<b>5</b> TRABAJOS EN EL SISTEMA ELÉCTRICO ..... 117	

## ÍNDICE

Acessórios e peças adquiridas localmente ..... 131	<b>6</b> ENSAIO DE FUNCIONAMENTO ..... 146
<b>1</b> PRECAUÇÕES DE SEGURANÇA ..... 132	<b>7</b> RESOLUÇÃO DE PROBLEMAS ..... 148
<b>2</b> SELECÇÃO DO LOCAL DE INSTALAÇÃO ..... 134	<b>8</b> CONTROLOS APLICÁVEIS ..... 149
<b>3</b> INSTALAÇÃO DA TUBAGEM DE DRENAGEM ..... 139	<b>9</b> FERRAMENTAS DE INSTALAÇÃO/ASSISTÊNCIA ..... 155
<b>4</b> TUBAGEM DE REFRIGERANTE E EVACUAÇÃO ..... 141	<b>10</b> MANUTENÇÃO ..... 155
<b>5</b> LIGAÇÕES ELÉTRICAS ..... 143	

## INHOUD

Accessoires en niet meegeleverde onderdelen ..... 157	<b>6</b> WERKINGSTEST ..... 172
<b>1</b> VOORZORGSMAATREGELEN VOOR UW VEILIGHEID . 158	<b>7</b> STORINGEN VERHELLEN ..... 174
<b>2</b> KEUZE VAN DE LOCATIE VOOR DE INSTALLATIE ..... 160	<b>8</b> BEDIENINGSELEMENTEN ..... 175
<b>3</b> AFVOERLEIDINGEN ..... 165	<b>9</b> INSTALLATIE EN ONDERHOUDSGEREEDSCHAPPEN 181
<b>4</b> KOELMIDDELLEIDINGEN EN ONTLUCHTEN ..... 167	<b>10</b> ONDERHOUD ..... 181
<b>5</b> ELEKTRISCH GEDEELTE ..... 169	

## ΠΕΡΙΕΧΟΜΕΝΑ

Παρελκόμενα ανταλλακτικά και Εξαρτήματα από την τοπική αγορά ..... 183	<b>5</b> ΗΛΕΚΤΡΟΛΟΓΙΚΑ ..... 195
<b>1</b> ΠΡΟΦΥΛΑΞΕΙΣ ΑΣΦΑΛΕΙΑΣ ..... 184	<b>6</b> ΔΟΚΙΜΗ ΛΕΙΤΟΥΡΓΙΑΣ ..... 198
<b>2</b> ΕΠΙΛΟΓΗ ΤΟΥ ΧΩΡΟΥ ΕΓΚΑΤΑΣΤΑΣΗΣ ..... 186	<b>7</b> ΑΝΤΙΜΕΤΩΠΙΣΗ ΠΡΟΒΛΗΜΑΤΩΝ ..... 200
<b>3</b> ΕΓΚΑΤΑΣΤΑΣΗ ΣΩΛΗΝΩΣΕΩΝ ΑΠΟΣΤΡΑΓΓΙΣΗΣ ..... 191	<b>8</b> ΕΦΑΡΜΟΣΙΜΟΙ ΕΛΕΓΧΟΙ ..... 201
<b>4</b> ΣΩΛΗΝΩΣΕΙΣ ΨΥΞΗΣ ΚΑΙ ΑΠΟΣΤΡΑΓΓΙΣΗΣ ..... 193	<b>9</b> ΕΡΓΑΛΕΙΑ ΕΓΚΑΤΑΣΤΑΣΗΣ/ ΕΠΙΣΚΕΥΗΣ ..... 207
	<b>10</b> ΣΥΝΤΗΡΗΣΗ ..... 207

ENGLISH

FRANCAIS

DEUTSCH

ITALIANO

ESPAÑOL



PORTUGUÊS



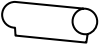

NEDERLANDS

ΕΛΛΗΝΙΚΑ

# Accessory parts and Parts to be procured locally

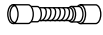
## □ Accessory parts

Part name	Q'ty	Shape	Usage
Owner's Manual	1	—	—
Installation Manual	1	This manual	—
Installation pattern	1	—	Drawing-out port of hanging bolt pipe
Thermal insulation pipe	2		For thermal insulation of pipe connecting section
Washer	4	M10 × Ø25	For holding down unit
Hose band	2		For connecting drain pipe

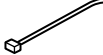
Part name	Q'ty	Shape	Usage
Drain hose	1		For connecting drain pipe
Bushing	1		For protection of edge at power taking-in port
Thermal insulator	1		For thermal insulation of drain hose (10t × 200 × 200)
Thermal insulator of top plate	1		For upper pipe hole of indoor unit (6t × 130 × 160)
Banding band	2		For prevention of open of drain hose thermal insulator

## <Separate sold parts>

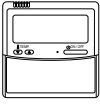
Part name	Q'ty	Shape	Usage
Standard wired remote controller	1		Model <b>RBC-AMT31E</b>

## □ Parts to be procured locally

Connecting pipe (Liquid side) (6.4mm (diam.), Nominal (diam.) 1/4" thick 0.8mm) RAV-SM562CT-E (9.5mm (diam.), Nominal (diam.) 3/8" thick 0.8mm) RAV-SM802CT-E, RAV-SM1102CT-E, RAV-SM1402CT-E
Connecting pipe (Gas side) (12.7mm (diam.), Nominal (diam.) 1/2" thick 0.8mm) RAV-SM562CT-E (15.9mm (diam.), Nominal (diam.) 5/8" thick 1.0mm) RAV-SM802CT-E, RAV-SM1102CT-E, RAV-SM1402CT-E
Power supply cord 2.5mm <sup>2</sup> (H07RN-F or 245IEC66) (20m or less) 3.5mm <sup>2</sup> (AWG-12) (50m or less)

Connecting cable (indoor and outdoor cable) H07RN-F or 245IEC66 (1.5mm <sup>2</sup> or more)
Thermal insulation for refrigerant pipe (10mm or more, thermal insulating foam polyethylene)
Thermal insulation for drain pipe (10mm or more, foam polyethylene)
Drain pipe (Outer 26mm (diam.)) (VP20)
Tapes

# 1 PRECAUTIONS FOR SAFETY

- Ensure that all Local, National and International regulations are satisfied.
- Read this "PRECAUTIONS FOR SAFETY" carefully before Installation.
- The precautions described below include the important items regarding safety. Observe them without fail.
- After the installation work, perform a trial operation to check for any problem.  
Follow the Owner's Manual to explain how to use and maintain the unit to the customer.
- Turn off the main power supply switch (or breaker) before the unit maintenance.
- Ask the customer to keep the Installation Manual together with the Owner's Manual.

## CAUTION

### New Refrigerant Air Conditioner Installation

- **THIS AIR CONDITIONER ADOPTS THE NEW HFC REFRIGERANT (R410A) WHICH DOES NOT DESTROY OZONE LAYER.**

The characteristics of R410A refrigerant are ; easy to absorb water, oxidizing membrane or oil, and its pressure is approx. 1.6 times higher than that of refrigerant R22. Accompanied with the new refrigerant, refrigerating oil has also been changed. Therefore, during installation work, be sure that water, dust, former refrigerant, or refrigerating oil does not enter the refrigerating cycle.

To prevent charging an incorrect refrigerant and refrigerating oil, the sizes of connecting sections of charging port of the main unit and installation tools are changed from those for the conventional refrigerant.

Accordingly the exclusive tools are required for the new refrigerant (R410A).

For connecting pipes, use new and clean piping designed for R410A, and please care so that water or dust does not enter. Moreover, do not use the existing piping because there are problems with pressure-resistance force and impurity in it.

## CAUTION

### To Disconnect the Appliance from Main Power Supply.

This appliance must be connected to the main power supply by means of a switch with a contact separation of at least 3 mm.

**The installation fuse (25A D type  ) must be used for the power supply line of this conditioner.**

## WARNINGS

- **Ask an authorized dealer or qualified installation professional to install/maintain the air conditioner.**  
Inappropriate installation may result in water leakage, electric shock or fire.
- **Turn off the main power supply switch or breaker before attempting any electrical work.**  
Make sure all power switches are off. Failure to do so may cause electric shock.
- **Connect the connecting cable correctly.**  
If the connecting cable is connected in a wrong way, electric parts may be damaged.
- **When moving the air conditioner for the installation into another place, be very careful not to enter any gaseous matter other than the specified refrigerant into the refrigeration cycle.**  
If air or any other gas is mixed in the refrigerant, the gas pressure in the refrigeration cycle becomes abnormally high and it resultingly causes pipe burst and injuries on persons.
- **Do not modify this unit by removing any of the safety guards or by by-passing any of the safety interlock switches.**
- **Exposure of unit to water or other moisture before installation may cause a short-circuit of electrical parts.**  
Do not store it in a wet basement or expose to rain or water.

# 1 PRECAUTIONS FOR SAFETY

- **After unpacking the unit, examine it carefully if there are possible damage.**
- **Do not install in a place that might increase the vibration of the unit.**
- **To avoid personal injury (with sharp edges), be careful when handling parts.**
- **Perform installation work properly according to the Installation Manual.**  
Inappropriate installation may result in water leakage, electric shock or fire.
- **When the air conditioner is installed in a small room, provide appropriate measures to ensure that the concentration of refrigerant leakage occur in the room does not exceed the critical level.**
- **Install the air conditioner securely in a location where the base can sustain the weight adequately.**
- **Perform the specified installation work to guard against an earthquake.**  
If the air conditioner is not installed appropriately, accidents may occur due to the falling unit.
- **If refrigerant gas has leaked during the installation work, ventilate the room immediately.**  
If the leaked refrigerant gas comes in contact with fire, noxious gas may generate.
- **After the installation work, confirm that refrigerant gas does not leak.**  
If refrigerant gas leaks into the room and flows near a fire source, such as a cooking range, noxious gas might generate.
- **Electrical work must be performed by a qualified electrician in accordance with the Installation Manual. Make sure the air conditioner uses an exclusive power supply.**  
An insufficient power supply capacity or inappropriate installation may cause fire.
- **Use the specified cables for wiring connect the terminals securely fix. To prevent external forces applied to the terminals from affecting the terminals.**
- **Conform to the regulations of the local electric company when wiring the power supply.**  
Inappropriate grounding may cause electric shock.
- **Do not install the air conditioner in a location subject to a risk of exposure to a combustible gas.**  
If a combustible gas leaks, and stays around the unit, a fire may occur.

# 2 SELECTION OF INSTALLATION PLACE

## ⚠ WARNING

- **Install the air conditioner at enough strong place to withstand the weight of the unit.**  
If the strength is not enough, the unit may fall down resulting in injury.
- **Perform a specified installation work to guard against an earth quake.**  
An incomplete installation can cause accidents by the units failing and dropping.
- **Install the air conditioner at a height 2.5m or more from the floor.**  
If you insert your hands or others directly into the unit while the air conditioner operates, it is dangerous because you may contact with revolving fan or active electricity.

## ⚠ CAUTION

- **Do not install the air conditioner in a location subject to a risk of exposure to a combustible gas.**  
If a combustible gas leaks and stays around the unit, a fire may occur.

**Upon approval of the customer, install the air conditioner in a place that satisfies the following conditions.**

- Place where the unit can be installed horizontally.
- Place where a sufficient servicing space can be ensured for safety maintenance and check.
- Place where drained water will not cause any problem.

**Avoid installing in the following places.**

- Place exposed to air with high salt content (seaside area), or place exposed to large quantities of sulfide gas (hot spring). (Should the unit be used in these places, special protective measures are needed.)
- Place exposed to oil, vapor, oil smoke or corrosive gas.
- Place where organic solvent is used nearby.
- Place close to a machine generating high frequency.
- Place where the discharged air blows directly into the window of the neighboring house. (For outdoor unit)
- Place where noise of the outdoor unit is easily transmitted.  
(When installing the air conditioner on the boundary with the neighbor, pay due attention to the level of noise.)
- Place with poor ventilation. (Before air ducting work, check whether value of air volume, static pressure and duct resistance are correct.)

## Installation space

Secure the specified space in the figure for installation and servicing.

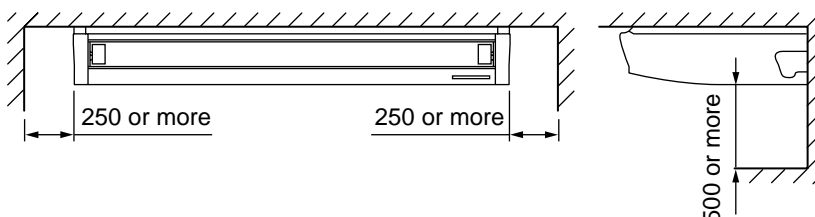

## 2 SELECTION OF INSTALLATION PLACE

### Height of ceiling

Set the installable height of the ceiling within 4m, otherwise the air distribution will become poor.

If height of ceiling exceeds 3.5m, hot air becomes difficult to reach the floor surface, and then the change of setup of high ceiling is necessary.

When incorporating a filter sold separately, the change of setup of high ceiling is also necessary.

For the change method of high ceiling, refer to the application control, "In case of installation to high ceiling" and "In case of incorporating filter sold separately" in this Manual.

### List of installable ceiling height

Setup data		
0000	Standard (At shipment)	3.5m or less
0001	High ceiling 1	4.0m or less

According to the conditions of installation, setup time of turning-on of filter sign (notification of filter cleaning) of the remote controller can be changed.

When it is difficult to warm up the room due to installation place or structure of the room, the detection temperature of heating can be raised.

For change the setup time, refer to the application control, "Change of filter sign turning-on time" and "How to increase the heating effect" in this Manual.

### In case of wireless type

Decide the position which remote controller is operated and the installation place.

And then refer to the Installation Manual of the wireless remote controller kit sold separately.

(The signal of the wireless type remote controller can be received within approx. 8m. This distance is a criterion and varies a little according to capacity of the battery, etc.)

- To prevent malfunction, select a place where is not affected by a fluorescent lamp or direct sunlight.
- Two or more (up to 6 units) wireless-type indoor units can be set in a room.

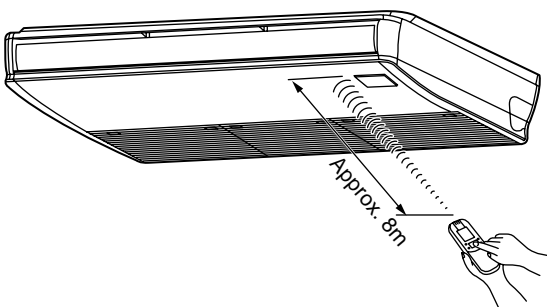

### Before installation

#### 1. Removal of suction grille

Slide the suction grille fixing knobs (two positions) toward the arrow direction, and then open the suction grille.

Under the condition of suction grille opened, push the hook section of hinges (two positions) at the rear side, and then pull out the suction grille.

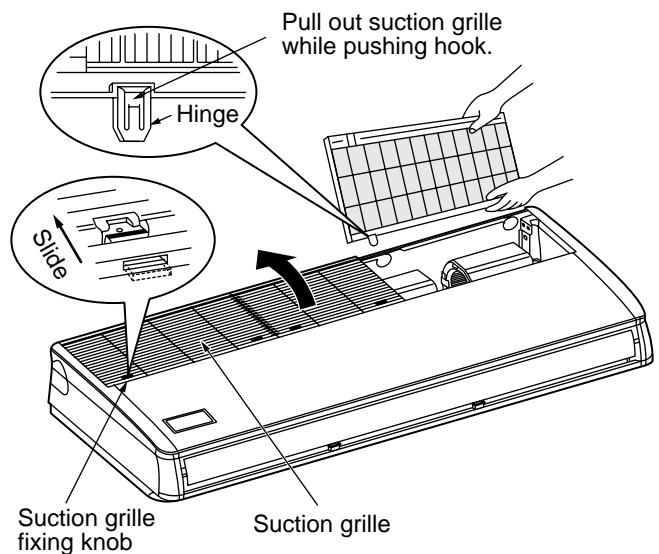

#### 2. Removal of side panel

After removing the side panel fixing screws (1 each at right and left), slide the side panel forward and then remove it.

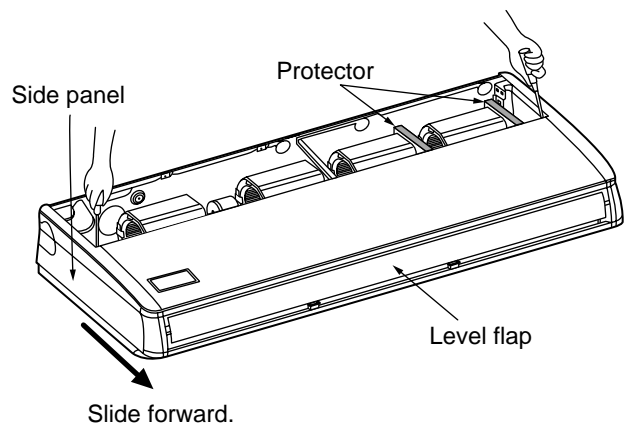

#### 3. Removal of protective vinyl

Peel out the protective vinyl on the level flap.

#### 4. Removal of protector

Remove the protectors (2 pcs.) of the fan. (RAV-SM802CT only)



## External view

### REQUIREMENT

Strictly comply with the following rules to prevent damage of the indoor units and human injury.

- Do not put a heavy article on the indoor unit. (Even units are packaged)
- Carry in the indoor unit as it is packaged if possible. If carrying in the indoor unit unpacked by necessity, be sure to use buffering cloth, etc. to not damage the unit.
- Do not apply force to the other parts (refrigerant pipe, drain pan, foamed parts, or resin parts, etc.).
- Carry the package by two or more persons, and do not bundle it with PP band at positions other than specified.

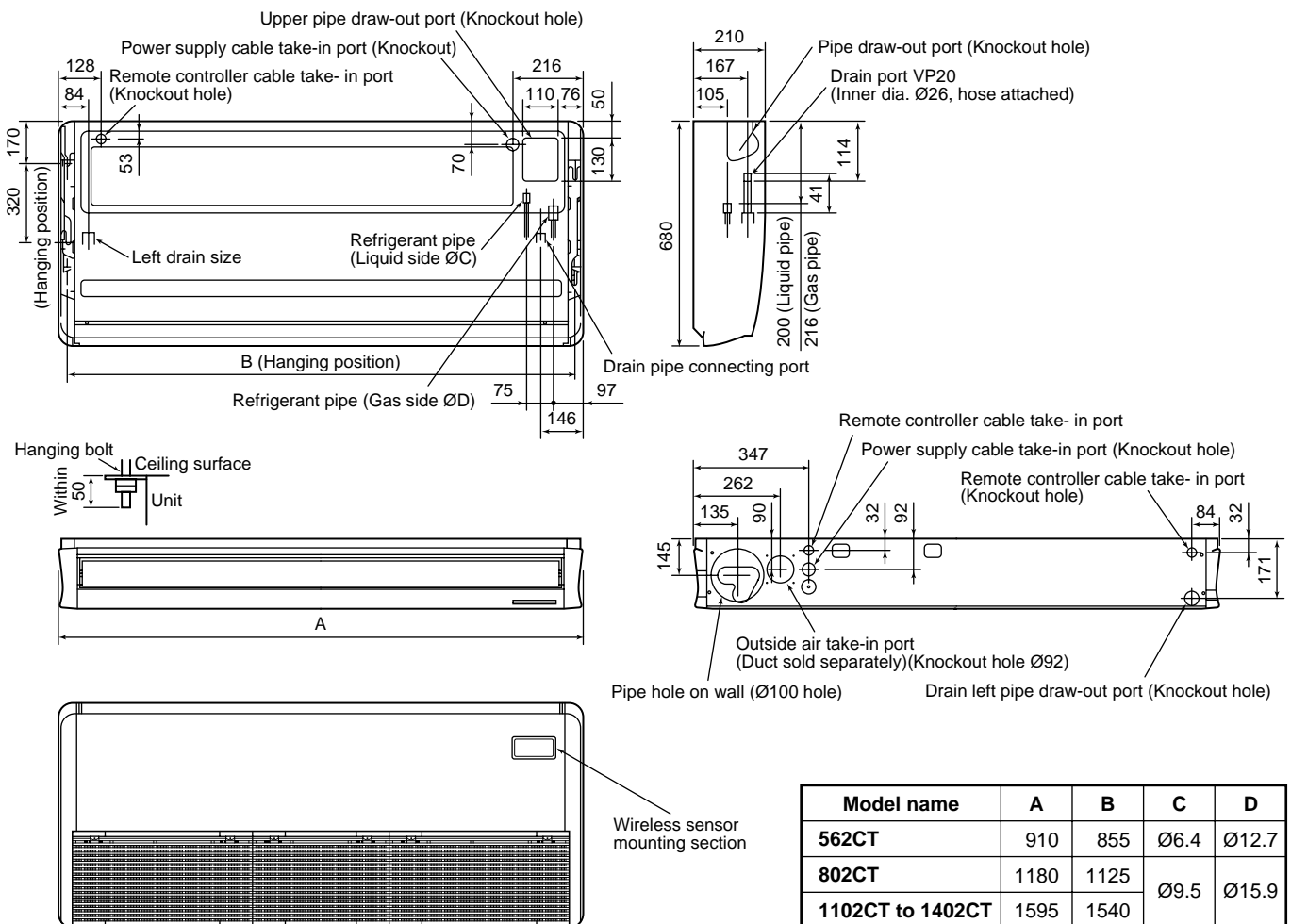

Considering pipe/wire connecting work inside the ceiling after the indoor unit has been hanged, select an installation place and determine piping direction.

- If the ceiling has already been set before hanging the main unit, prepare refrigerant pipe, drain pipe, indoor connecting wire, remote controller cord, etc. up to the place where pipe and wire can be connected.
- Check the size of the indoor unit, and match the indoor unit size using the attached installation pattern.

### How to use attached installation pattern

Using the pattern, positioning of the hanging bolt and pipe hole can be performed.

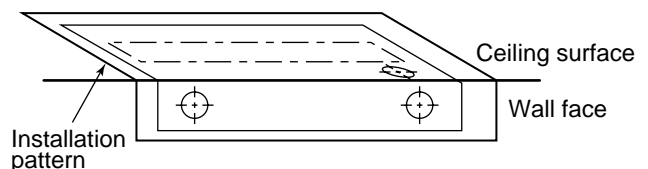

- \* As an error to some degree may generate on the pattern size due to temperature and humidity, be sure to confirm the size.



## 2 SELECTION OF INSTALLATION PLACE

### Installation of hanging bolts

Use M10 hanging bolts (4 pcs, to be local procure). Matching to the existing structure, set pitch according to size in the unit external view as shown below.

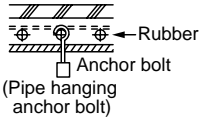
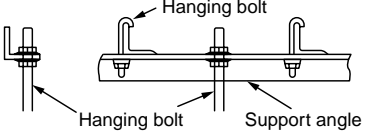
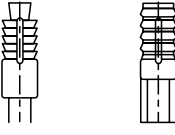
New concrete slab
Install the bolts with insert brackets or anchor bolts. <div style="display: flex; justify-content: space-around; align-items: center; margin-top: 10px;">    </div> <div style="display: flex; justify-content: space-around; margin-top: 5px;"> <span>(Blade type bracket)</span> <span>(Slide type bracket)</span> <span>(Pipe hanging anchor bolt)</span> </div>
Steel frame structure
Use existing angles or install new support angles. <div style="text-align: center; margin-top: 10px;">  </div>
Existing concrete slab
Use a hole-in anchors, hole-in plugs, or a hole-in bolts. <div style="text-align: center; margin-top: 10px;">  </div>

### Draw-out direction of pipe/cable

- Decide installation place of the unit and draw-out direction of pipe and cable.

### Knockout hole of power cable take-in port

Open the power cable take-in port (Knockout hole) shown in the external view and then mount the attached bushing.

### Pipe knockout hole

- In case of taking pipe from the rear side**
  - \* Cut off the groove section with a plastic cutter, etc.

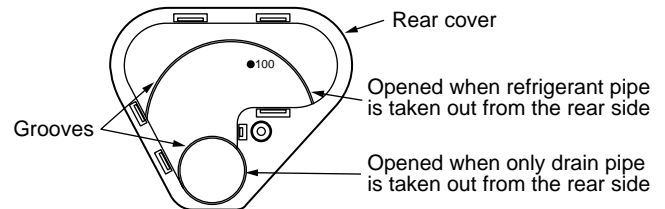

- In case of taking pipe from right side**

- \* Cut off the groove section with a metal saw or plastic cutter, etc.

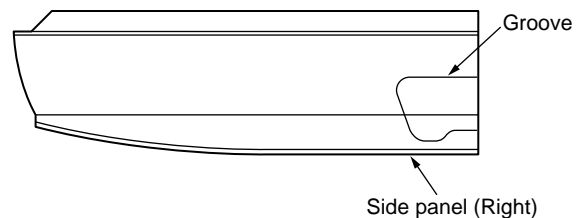

- In case of taking pipe from left side**

**Taking pipe from left side is applied only to the drain pipe.**

**The refrigerant pipe cannot be taken out from the left side.**

- \* Cut off the groove section with a metal saw or plastic cutter, etc.

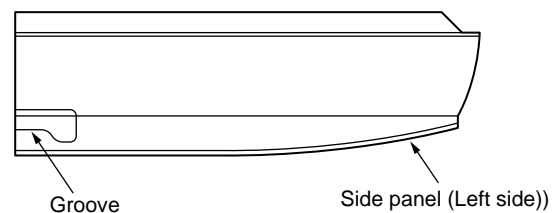

- In case of taking pipe from upper side**

**Taking pipe from upper side is applied only to the refrigerant pipe.**

**When taking out the drain pipe from the upper side, use a drain up kit sold separately.**

Open the upper pipe draw-out port (Knockout hole) shown in the external view. (Knockout hole of thin plate)

After piping, cut off the attached thermal insulator of the top plate to pipe shape, and then seal the knockout hole.

## Installation of indoor unit

### • Preparation before holding down main unit

- \* Confirm the presence of the ceiling material beforehand because the fixing method of hanging metal when the ceiling material is set differs from that when the ceiling material is not set.

#### <There is ceiling material>

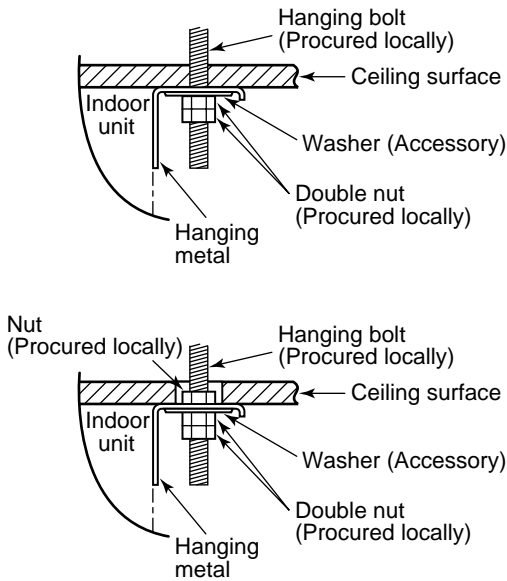

- \* Tighten the hanging metal with upper/lower nuts as shown in the figure.

#### <There is no ceiling material>

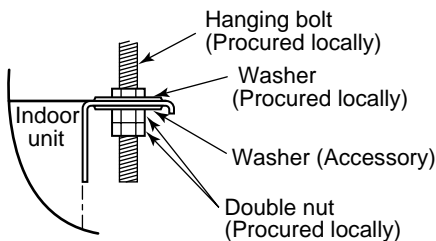

### • Holding down of main unit

- 1) Attach washer and nuts to the hanging bolt.

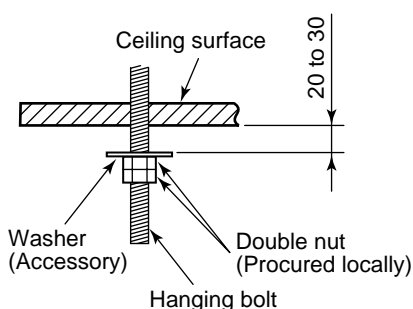

- 2) Hang the unit to the hanging bolt as shown the figure below.

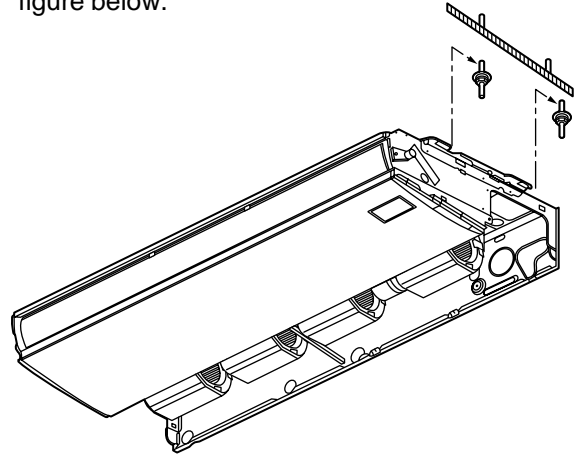

- 3) As shown in the figure below, fix the ceiling material securely with the double nuts.

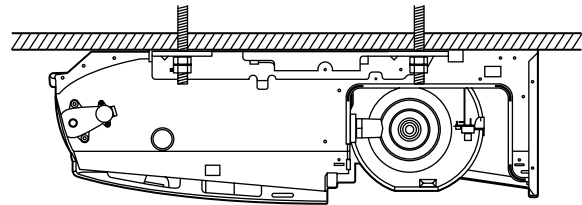

## REQUIREMENT

- The ceiling surface may not be horizontal. Be sure to confirm that width and depth directions are level.

## Installation of remote controller (Sold separately)

For installation of the wired remote controller, follow the Installation Manual attached with the remote controller.

- Pull out the remote controller cord together with the refrigerant pipe or drain pipe. Be sure to pass the remote controller cord through upper side of the refrigerant pipe and drain pipe.
- Do not leave the remote controller at a place exposed to the direct sunlight and near a stove.
- Operate the remote controller, confirm that the indoor unit receives a signal surely, and then install it. (Wireless type)
- Keep 1m or more from the devices such as television, stereo, etc. (Disturbance of image or noise may generate.) (Wireless type)

# 3 DRAIN PIPING WORK

## CAUTION

- Following the Installation Manual, perform the drain piping work so that water is properly drained, and apply a heat insulation so as not to cause a dew. Inappropriate piping work may result in water leakage in the room and wet of furniture.

## Piping/Heat insulating material

Require the following materials for piping and heat insulating at site.

<b>Piping</b>	Hard vinyl chloride pipe VP20 (Outer dia. : Ø26mm)
<b>Heat insulator</b>	Foam polyethylene : Thickness 10mm or more

## REQUIREMENT

- Be sure to perform heat insulation of the drain pipes of the indoor unit.
- Never forget to perform heat insulation of the connecting part with the indoor unit. An incomplete heat insulation causes dewing.
- Set the drain pipe with downward slope (1/100 or more), and do not make swelling or trap on the piping. It may cause an abnormal sound.
- For length of the traversing drain pipe, restrict to 20m or less. In case of a long pipe, provide support brackets with interval of 1.5 to 2m in order to prevent waving.

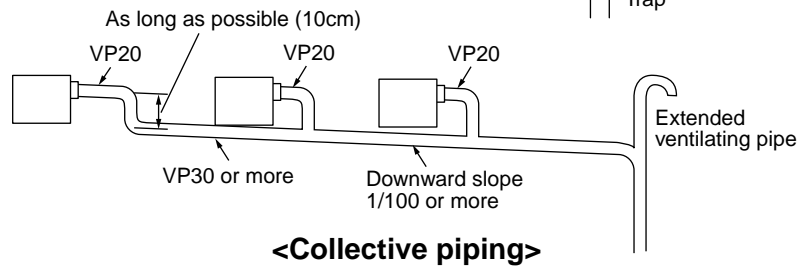
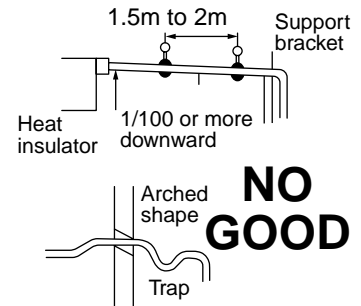

- Set the collective piping as shown in the right figure.
- Be sure not to apply force to the connecting part of the drain pipe.
- The hard vinyl-chloride pipe cannot be directly connected to the drain pipe connecting port of the indoor unit. For connection with the drain pipe connecting port, be sure to use/fix the attached flexible hose with the hose band, otherwise a damage or water leak is caused on the drain pipe connecting port.

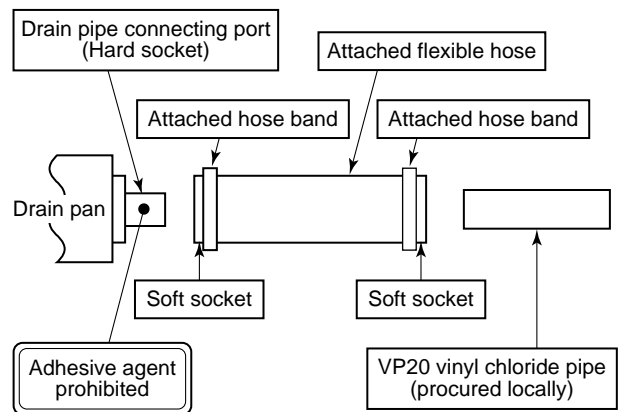

### Adhesive inhibited :

Use the attached flexible hose and hose band for connecting the drain hose to the clear drain socket. If applying the adhesive, socket will be damaged and cause water leakage.

## Drain up

When not securing down slope on the drain pipe, use a drain up kit sold separately. Also refer to the "Drain up kit installation manual".

The drain pipe can be raised 60cm from the top face of the main unit.

\* When using drain up kit, both drain pipe and refrigerant pipe can be taken only from upper side.

## Connection of drain hose

- Insert the attached drain hose into the drain pipe connecting port on the drain pan up to the end.
- Fit the attached hose band to the end of the pipe connecting port, and then tighten it securely.

### REQUIREMENT

- Be sure to fix the drain hose with the attached hose band, and set the tightening position upward.
- As the draining is the natural water draining, arrange the pipe outside of the unit on the down slope.
- If piping is performed as shown in the figure, drain cannot be discharged.

### NO GOOD

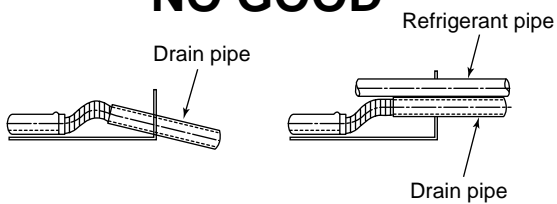

## Thermal insulating process

- Using the attached drain hose thermal insulator, lap the connecting section and the drain hose without clearance, and then tighten with two handing band so that thermal insulator does not open.
- Covering the attached drain hose thermal insulator, lap the thermal insulator (procured locally) to the drain pipe without clearance.

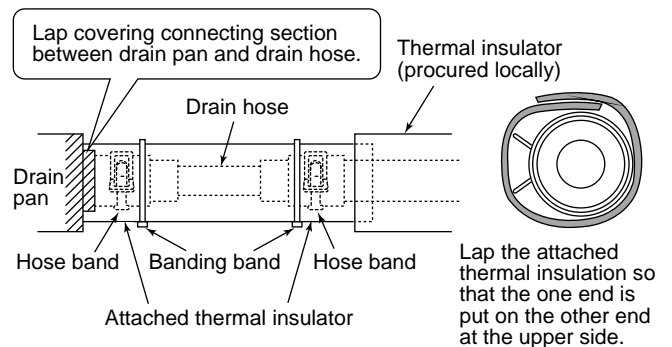

\* Tighten the banding band so that attached thermal insulator is not pushed excessively.

## Connection of drain pipe

- Connect the hard vinyl chloride pipe (procured locally) to the mounted drain hose which was attached.
- **In case of taking pipe from the left side**
  - In case of taking pipe from the left side, exchange the plug from left to right. Push in the plug of which end is not sharp up to the end.

Fit the attached hose band to the end of the hose, lay down the knob, and then tighten hose band.

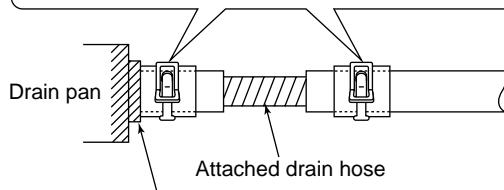

Confirm that soft hose is pushed in up to the end of the drain pan.

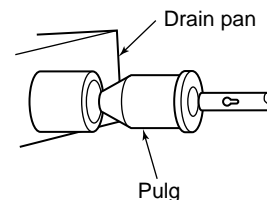

# 4 REFRIGERANT PIPING AND EVACUATING

## Refrigerant Piping

- The connecting sections of the refrigerant pipes are provided at the positions in the figure below.

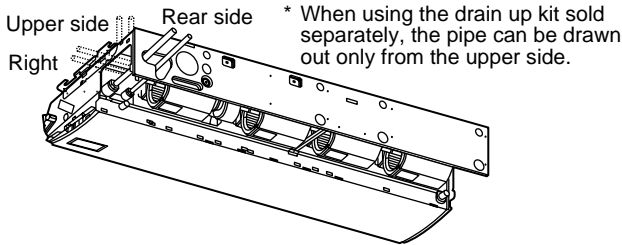

- Use copper pipe with 0.8 mm or more thickness. (In case pipe size is  $\varnothing 15.9$ , with 1.0mm or more.)
- Flare nut and flare works are also different from those of the conventional refrigerant. Take out the flare nut attached to the main unit of the air conditioner, and use it.

### CAUTION

#### IMPORTANT 4 POINTS FOR PIPING WORK

- Remove dust and moisture from the inside of the connecting pipes.
- Tight connection (between pipes and unit)
- Evacuate the air in the connecting pipes using VACUUM PUMP.
- Check the gas leakage. (Connected points)

## Permissible Piping Length and Heat

They vary according to the outdoor unit. For details, refer to the Installation Manual attached to the outdoor unit.

## Flaring

Insert a flare nut into the pipe, and flare the pipe. As the flaring sizes of R410A differ from those of refrigerant R22, the flare tools newly manufactured for R410A are recommended. However, the conventional tools can be used by adjusting projection margin of the copper pipe.

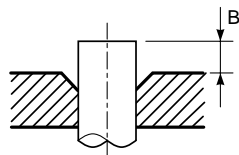

- Projection margin in flaring : B (Unit : mm)

Rigid (Clutch type)

Outer diam. of copper pipe	R410A tool used		Conventional tool used	
	R410A	R22	R410A	R22
6.4 to 15.9	0 to 0.5	(Same as left)	1.0 to 1.5	0.5 to 1.0

Imperial (Wing nut type)

Outer diam. of copper pipe	R410A	R22
6.4 or 9.5	1.5 to 2.0	1.0 to 1.5
12.7 or 15.9	2.0 to 2.5	1.5 to 2.0

- Flaring diam. meter size : A (Unit : mm)

Outer diam. of copper pipe	A $\begin{matrix} +0 \\ -0.4 \end{matrix}$	
	R410A	R22
6.4	9.1	9.0
9.5	13.2	13.0
12.7	16.6	16.2
15.9	19.7	19.2

- In case of flaring for R410A with the conventional flare tool, pull it out approx. 0.5 mm more than that for R22 to adjust to the specified flare size. The copper pipe gauge is useful for adjusting projection margin size.

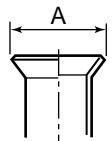

## Tightening connection

### CAUTION

- Do not apply excessive torque. Otherwise, the nut may crack depending on the conditions.

(Unit : N•m)

Outer diam. of copper pipe	Tightening torque
6.4 mm (diam.)	14 to 18 (1.4 to 1.8 kgf•m)
9.5 mm (diam.)	33 to 42 (3.3 to 4.2 kgf•m)
12.7 mm (diam.)	50 to 62 (5.0 to 6.2 kgf•m)
15.9 mm (diam.)	63 to 77 (6.3 to 7.7 kgf•m)

- Tightening torque of flare pipe connections

Pressure of R410A is higher than that of R22. (Approx. 1.6 times) Therefore, using a torque wrench, tighten the flare pipe connecting sections which connect the indoor and outdoor units of the specified tightening torque. Incorrect connections may cause not only a gas leak, but also a trouble of the refrigeration cycle.

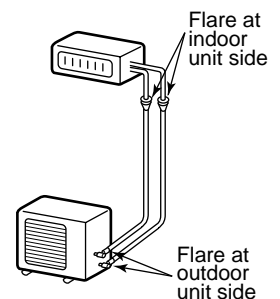

Align the centers of the connecting pipes and tighten the flare nut as far as possible with your fingers. Then tighten the nut with a spanner and torque wrench as shown in the figure.

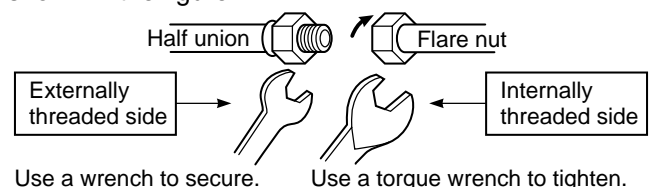

Use a wrench to secure.

Use a torque wrench to tighten.

### **Piping with outdoor unit**

- Shape of valve differs according to the outdoor unit. For details of installation, refer to the Installation Manual of the outdoor unit.

### **Air purge**

Using a vacuum pump, perform vacuuming from the charge port of valve of the outdoor unit.

For details, follow to the Installation Manual attached to the outdoor unit.

- Never use the refrigerant sealed in the outdoor unit for air purge.

### **REQUIREMENT**

For the tools such as charge hose, etc., use those manufactured exclusively for R410A.

### **Refrigerant amount to be added**

For addition of the refrigerant, add refrigerant "R410A" referring to the attached Installation Manual of outdoor unit.

Be sure to use a scale to charge the refrigerant of specified amount.

### **REQUIREMENT**

- Charging an excessive or too little amount of refrigerant causes a trouble of the compressor. Be sure to charge the refrigerant of specified amount.
- A personnel who charged the refrigerant should write down the pipe length and the added refrigerant amount in the nameplate attached to the service panel of the outdoor unit. It is necessary to troubleshoot the compressor and refrigeration cycle malfunction.

### **Open the valve fully**

Open the valve of the outdoor unit fully. A 4mm-hexagonal wrench is required for opening the valve.

For details, refer to the Installation Manual attached to the outdoor unit.

### **Gas leak check**

Check with a leak detector or soap water whether gas leaks or not, from the pipe connecting section or cap of the valve.

### **REQUIREMENT**

Use a leak detector manufactured exclusively for HFC refrigerant (R410A, R134a, etc.).

### **Thermal insulation process**

Apply thermal insulation for the pipes separately at liquid side and gas side.

For the thermal insulation to the pipes at gas side, be sure to use the material with heat-resisting temperature 120°C or higher.

Using the attached thermal insulation material, apply the thermal insulation to the pipe connecting section of the indoor unit securely without gap.

### **REQUIREMENT**

Apply the thermal insulation to the pipe connecting section of the indoor unit securely up to the root without exposure of the pipe. (The pipe exposed to the outside causes water leak.)

# 5 ELECTRICAL WORK

## WARNING

1. **Using the specified cables, ensure to connect the wires, and fix wires securely so that the external tension to the cables do not affect the connecting part of the terminals.**

Incomplete connection or fixation may cause a fire, etc.

2. **Be sure to connect earth wire. (Grounding work)**

Do not connect the earth wire to gas pipe, city water pipe, lightning rod, or the earth wire of telephone. Incomplete grounding causes an electric shock.

3. **For electric work, strictly follow the Local Regulation in each country and the Installation Manual, and use an exclusive circuit.**

Capacity shortage of power circuit or incomplete installation may cause an electric shock or a fire.

## CAUTIONS

- This indoor unit has no power cord.
- If incorrect/incomplete wiring is carried out, it will cause an electrical fire or smoke.
- Be sure to install an earth leakage breaker that is not tripped by shock waves.  
If an earth leakage breaker is not installed, an electric shock may be caused.
- Be sure to use the cord clamps attached to the product.
- Do not damage or scratch the conductive core and inner insulator of power and inter-connecting cables when peeling them.
- Be sure to comply with local regulations on running the wire from outdoor unit to indoor unit (size of wire and wiring method etc.)
- Use the power cord and Inter-connecting cable of specified thickness, type, and protective devices required.

## REQUIREMENT

- For power supply wiring, strictly conform to the Local Regulation in each country.
- For wiring of power supply of the outdoor units, follow the Installation Manual of each outdoor unit.
- Never connect 220–240V power to the terminal blocks (A, B, etc.) for control wiring.  
(Otherwise, the system will fail.)
- Perform the electric wiring so that it does not come to contact with the high-temperature part of the pipe.  
The coating may melt resulting in an accident.
- After connecting cables to the terminal blocks, provide a trap and fix cables with the cable clamp.
- Run the refrigerant piping line and control wiring line in the same line.
- Do not turn on the power of the indoor unit until vacuuming of the refrigerant pipes completes.

### Remote controller wiring

2-core non polarity cable is used for the remote controller wiring.

### How to wire

1. Connect the connecting cable to the terminal as identified with their respective numbers on the terminal block of indoor and outdoor unit. H07 RN-F or 245 IEC 66 (1.5 mm<sup>2</sup> or more)
2. Mount a leakage breaker.
3. Insulate the unsheathed redundant cords (conductors) with tape.
4. For inter-unit wiring, do not use a wire jointed to another on the way.
5. Fix the cable with cord clamp.



## Cable connection

### REQUIREMENT

- Be sure to connect the cables matching the terminal numbers. Incorrect connection causes a trouble.
  - Be sure to pass the cables through the bushing of cabling connection port of the indoor unit.
  - Keep a margin (Approx. 100mm) on a cable to hang down the electric parts box at servicing, etc.
  - The low-voltage circuit is provided for the remote controller. (Do not connect the high-voltage circuit)
- 
- Loosen the cover mounting screws (2 positions) of the electric parts box, and then remove the cover.
  - Slit the film of bushing attached to the power take-in port and remote controller cable take-in port, and then pass through cables.
  - Connect the indoor/outdoor connecting cables and the remote controller cable to the terminal block of the electric parts box.
  - Tighten screws of the terminal block securely, and fix the cables with code clamp attached to the electric parts box.
  - Mount the cover of the electric parts box so that it does not pinch the cables.

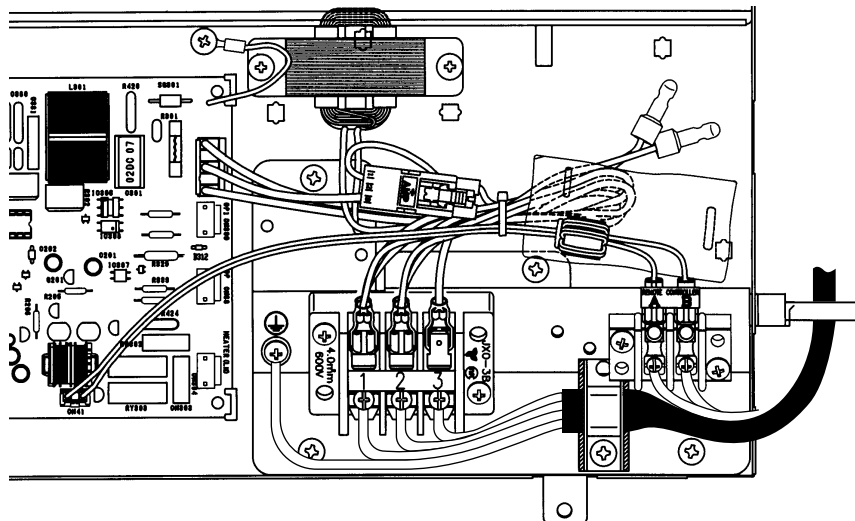
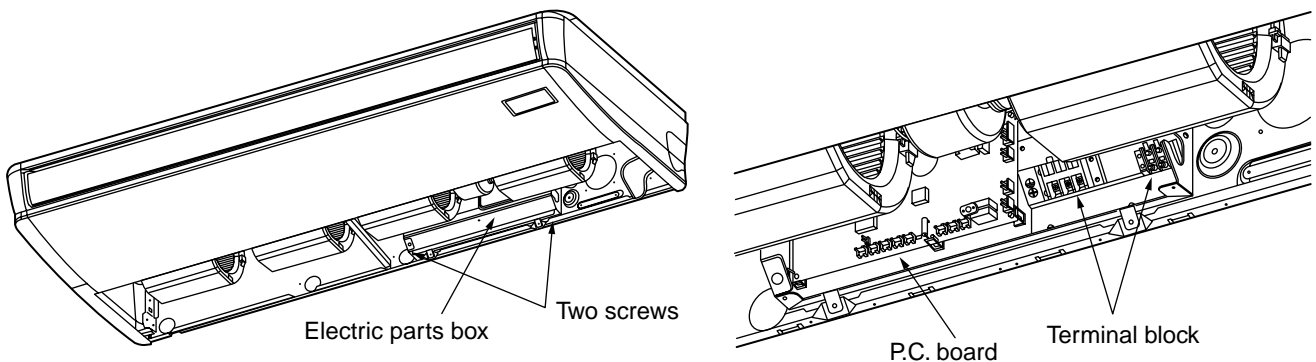

# 5 ELECTRICAL WORK

## Cabling

1. Remove a screw and then remove cover of the electric parts box.
2. Strip wire ends (10 mm).
3. Match wire colors with terminal numbers on indoor and outdoor units' terminal blocks and firmly screw wires to the corresponding terminals.
4. Connect the ground wires to the corresponding terminals.
5. Fix the cable with cord clamp.
6. Fix cover of the parts box and the terminal block surely with the fixing screws.

Make a loop on the cable for margin of the length so that the electric parts box can be taken out during servicing.

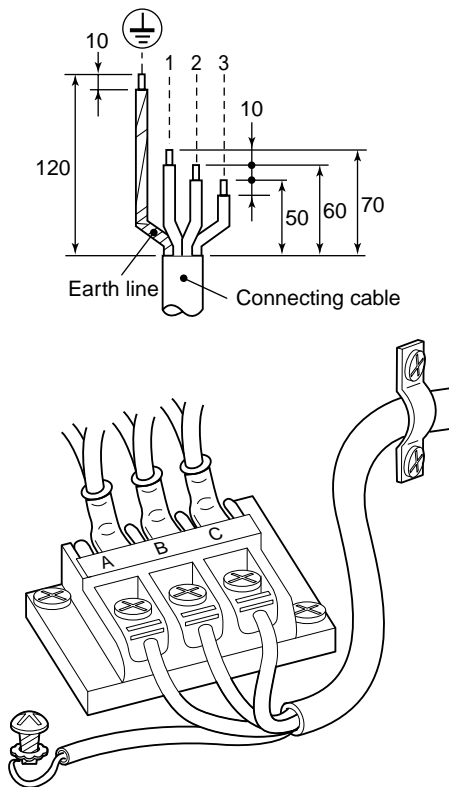

## Remote Controller Cabling

- Strip off approx. 9mm the cable to be connected.
- Non polarity, 2 core cable is used for cabling of the remote controller.

## Cabling diagram

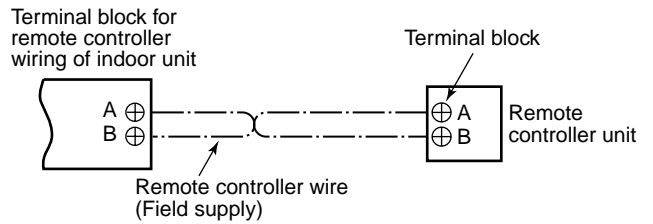

## Wiring diagram

### <Single system>

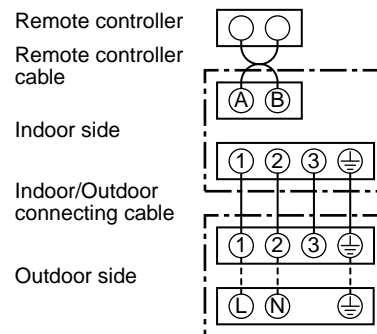

### <Synchronous twin system>

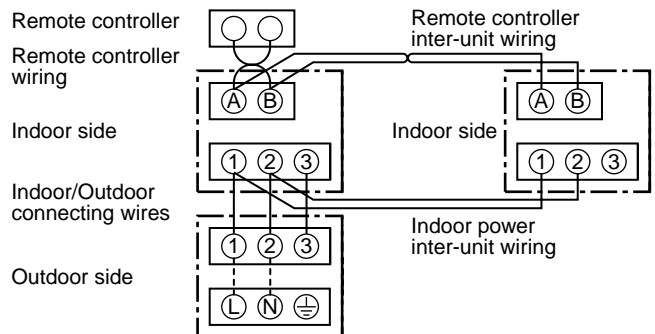

- For details of cabling/installation of the remote controller, refer to the Installation Manual attached to in the remote controller.

# 6 TEST RUN

## Before test run

- Before turning on the power supply, carry out the following procedure.
  - 1) Using 500V-megger, check 1MΩ or more exists between the terminal block 1 to 3 and the earth.  
If 1MΩ or less is detected, do not run the unit. Do not apply to the remote controller circuit.
  - 2) Check the valve of the outdoor unit being opened fully.
- To protect the compressor at activation time, leave power-ON for 12 hours or more before operating.

## How to execute a test run

Using the remote controller, operate the unit as usual.

For the procedure of the operation, refer to the attached Owner's Manual.

A forced test run can be executed in the following procedure if the operation stops by thermo.-OFF.

In order to prevent a serial operation, the forced test run is released after 60 minutes have passed and returns to the usual operation.

## CAUTION



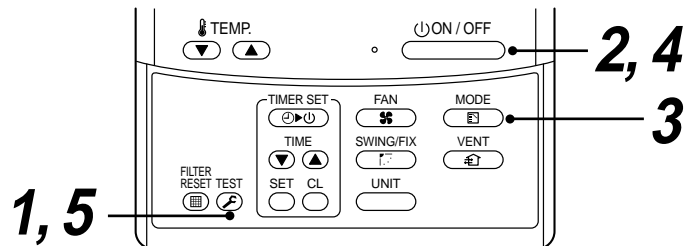

When the remote controller is used for the first time, it accepts an operation approx. 5 minutes after the power supply has been turned on.  
It is not a trouble, but is because the setup of the remote controller is being checked.  
For the second power-ON time and after, approx. 1 minute is required to start the operation by the remote controller.

## NOTE

Do not use the forced test run for cases other than the test run because it applies an excessive load to the devices.

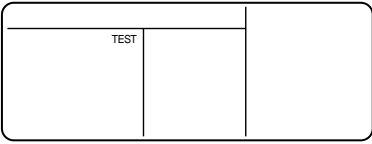
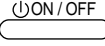

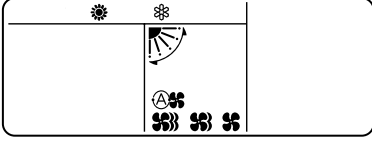
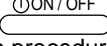
## In case of wired remote controller

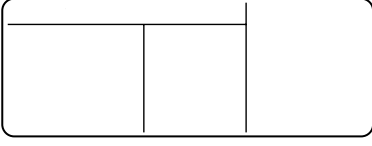
Procedure	Description
<b>1</b>	Keep  button pushed for 4 seconds or more. [TEST] is displayed on the display part and the selection of mode in the test mode is permitted. 
<b>2</b>	Push  button.
<b>3</b>	Using  button, select the operation mode, [COOL] or [HEAT]. <ul style="list-style-type: none"> <li>• Do not run the air conditioner in a mode other than [COOL] or [HEAT].</li> <li>• The temperature controlling function does not work during test run.</li> <li>• The detection of error is performed as usual.</li> </ul> 
<b>4</b>	After the test run, push  button to stop a test run. (Display part is same as procedure <b>1</b> .)
<b>5</b>	Push  check button to cancel (release from) the test run mode. ([TEST] disappears on the display and the status returns to a normal.) 

# 6 TEST RUN

## In case of wireless remote controller

Procedure	Description	
<b>1</b>	Turn on power of the air conditioner.	
	The operation is not accepted for 5 minutes when power has been turned on at first time after installation, and 1 minute when power has been turned on at the next time and after. After the specified time has passed, perform a test operation.	
<b>2</b>	Push <b>[Start/Stop]</b> button and change the operation mode to <b>[COOL]</b> or <b>[HEAT]</b> with <b>[Mode]</b> button. Then change the fan speed to <b>[High]</b> using <b>[Fan]</b> button.	
<b>3</b>	Test cooling operation	Test heating operation
	Set temperature to <b>[18°C]</b> using <b>[Temperature set]</b> button.	Set temperature to <b>[30°C]</b> using <b>[Temperature set]</b> button.
<b>4</b>	After checking the receiving sound "Pi", immediately push <b>[Temperature set]</b> button to set to <b>[19°C]</b>	After checking the receiving sound "Pi", immediately push <b>[Temperature set]</b> button to set to <b>[29°C]</b> .
<b>5</b>	After checking the receiving sound "Pi", immediately push <b>[Temperature set]</b> button to set to <b>[18°C]</b> .	After checking the receiving sound "Pi", immediately push <b>[Temperature set]</b> button to set to <b>[30°C]</b> .
<b>6</b>	Then repeat the procedure <b>4</b> → <b>5</b> → <b>4</b> → <b>5</b> .	
	After approx. 10 seconds, all the display lamps on the sensor part of wireless remote controller, <b>[Operation]</b> (Green), <b>[Timer]</b> (Green), and <b>[Ready]</b> (Yellow) flash and the air conditioner starts operation. If the lamps do not flash, repeat the procedure <b>2</b> and after.	
<b>7</b>	After the test operation, push <b>[Start/Stop]</b> button to stop the operation.	

### <Outline of test operation from the wireless remote controller>

Test cooling operation:

Start/Stop → 18°C → 19°C → 18°C → 19°C → 18°C → 19°C → 18°C → (Test operation) → Start/Stop

Test heating operation:

Start/Stop → 30°C → 29°C → 30°C → 29°C → 30°C → 29°C → 30°C → (Test operation) → Start/Stop

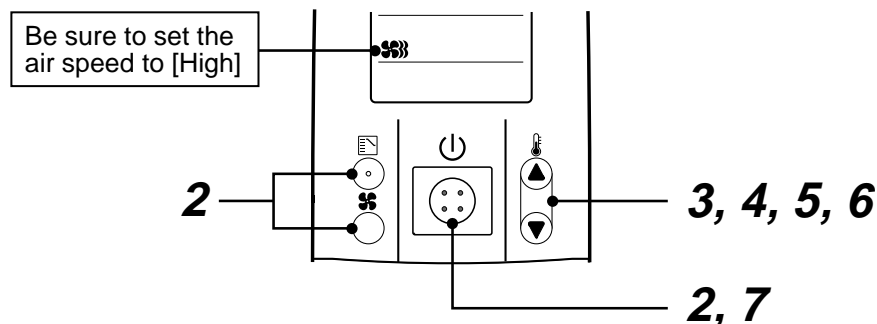

# 7 TROUBLESHOOTING

## Confirmation and check

When a trouble occurred in the air conditioner, the check code and the indoor unit No. appear on the display part of the remote controller.

The check code is only displayed during the operation.  
If the display disappears, operate the air conditioner according to the following "Confirmation of error history" for confirmation.

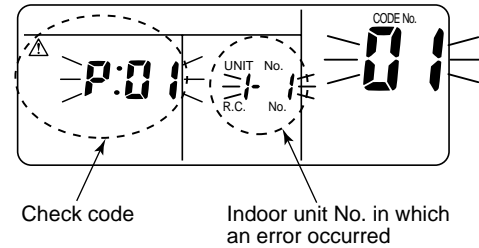

## Confirmation of error history

When a trouble occurred on the air conditioner, the trouble history can be confirmed with the following procedure. (The trouble history is stored in memory up to 4 troubles.)

The history can be confirmed from both operating status and stop status.

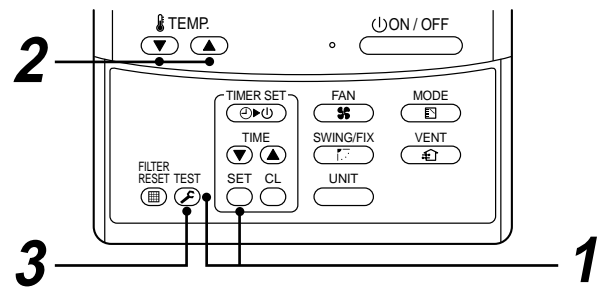

Procedure	Description
1	<p>When pushing <b>SET</b> and <b>TEST</b> buttons at the same time for 4 seconds or more, the following display appears.</p> <p>If [Service check] is displayed, the mode enters in the trouble history mode.</p> <ul style="list-style-type: none"> <li>• [01 : Order of trouble history] is displayed in CODE No. window.</li> <li>• [Check code] is displayed in CHECK window.</li> <li>• [Indoor unit address in which an error occurred] is displayed in UNIT No.</li> </ul>
2	<p>Every pushing of [ <b>▼</b> , <b>▲</b> ] button used to set temperature, the trouble history stored in memory is displayed in order.</p> <p>The numbers in CODE No. indicate CODE No. [01] (latest) → [04] (oldest).</p> <p><b>REQUIREMENT</b></p> <p>Do not push <b>CL</b> button because all the trouble history of the indoor unit will be deleted.</p>
3	<p>After confirmation, push <b>TEST</b> button to return to the usual display.</p>

1. Check the troubles according to the above procedure.
2. Ask an authorized dealer or qualified service (maintenance) professional to repair or maintain the air conditioner.
3. More details of the service code are explained in Service Manual.

# 8 APPLICABLE CONTROLS

## NOTIFICATION

When using the equipment at the first time, it will take a lot of time that the remote controller accepts an operation after power was on. However, it is not a trouble.

- **Automatic address**
  - While automatic addressing, the operation cannot be performed on the remote controller.
  - For automatic addressing, Max. 10 minutes (generally, approx. 5 minutes) are required.
- **When power will be turned on after finish of automatic addressing;**
  - It will require Max. 10 minutes (generally, approx. 3 minutes) that outdoor unit starts operation after power was on.

As all the buttons have been set to [Standard] at the shipment, change the setup of the indoor unit if necessary. To change the setup, use the main remote controller (wired remote controller).

\* The setup change for wireless remote controller, sub remote controller, or remote controller-less system (Central control remote controller only is provided.) is impossible. In these cases, prepare and mount a separate main remote controller.

## Exchange of applicable control setup

### Basic operation procedure for setup exchange

Change the setup while operation of the equipment stops.  
(Be sure to stop the operation of a set.)

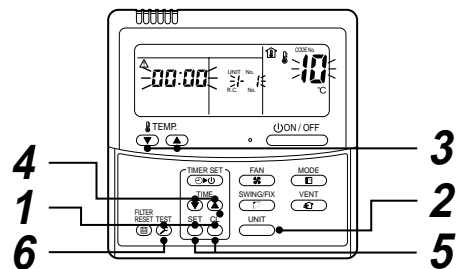

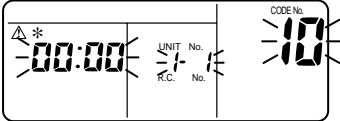
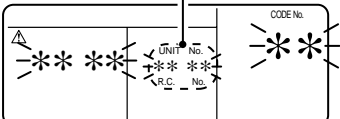
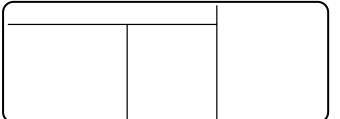
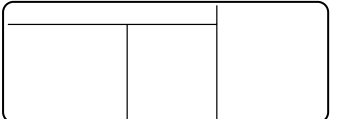
Procedure	Description
1	<p>When pushing <b>SET</b>, <b>CL</b>, and <b>TEST</b> buttons simultaneously for 4 seconds or more, after a while, the display part flashes as shown in the figure.</p> <p>Check that the displayed item code is [10].</p> <ul style="list-style-type: none"> <li>• If the item code indicates other than [10], push <b>TEST</b> button to erase the display, and then retry the operation from the first step. (For some time after <b>TEST</b> button has been pushed, the operation of the remote controller cannot be accepted.)</li> </ul> <p>(In a group control, the firstly displayed indoor unit No. becomes the master unit.)</p> <p style="text-align: right;">(* The display changes according to the indoor unit model.)</p> 
2	<p>Every pushing <b>UNIT</b> button, the indoor unit No. in the group control is displayed successively. Select an indoor unit of which setup to be changed.</p> <p>In this time, the position of the indoor unit of which setup to be changed can be confirmed because the fan and the flap of the selected indoor unit work.</p>
3	<p>Using <b>▲</b>, <b>▼</b> buttons of set temperature, specify the item code [**].</p> 
4	<p>Using <b>▲</b>, <b>▼</b> buttons of set timer, select set data [****].</p> 
5	<p>Push <b>SET</b> button. In this time, if the display changes from flashing to lighting, the setup completes.</p> <ul style="list-style-type: none"> <li>• To change the setup of an indoor unit other than the selected one, start operation from Procedure 2.</li> <li>• To change the setup of another setup in the selected indoor unit, start operation from Procedure 3.</li> </ul> <p>Pushing <b>CL</b> button clears the set up contents which have been already set. In this case, retry from Procedure 2.</p>
6	<p>When the setup finished, push <b>TEST</b> button. (The setup is determined.)</p> <p>Pushing <b>TEST</b> button deletes the display and returns the status to normal stop status.</p> <p>(For some time after <b>TEST</b> button has been pushed, the operation of the remote controller cannot be accepted.)</p> 

### In case of installation to high ceiling

When the height of the ceiling to be installed exceeds 3.5m, adjustment of air volume is necessary.  
Set up the high ceiling.

- Set according to the basic operation procedure (1 → 2 → 3 → 4 → 5 → 6).
- Item code in Procedure specifies [5d].
- Select [Set data] in Procedure from “List of installable ceiling height” in this Manual.
- For the item code in Procedure 3, specify [5d].
- For the set data in Procedure 4, select the setup data of static pressure to be set up from the table below.

#### (Exchange by wired remote controller)

Set data		
0000	Standard (At shipment)	3.5m or less
0001	High static pressure 1	4.0m or less

### When using wireless remote controller



To exchange the static pressure, there is a method other than the abovementioned method by wired remote controller, which is to shift the short plug on the indoor microcomputer P.C. board as shown in the following table. Adopt this method in case of using a wireless remote controller, etc.

\* However, after exchanging once, be careful to shift the short plug to the standard position (At shipment) in order to return to the standard setup (follow to E2PROM setup) though the setup for high static-pressure 1, high static-pressure 2, or low static-pressure can be arbitrarily performed.

It is necessary to rewrite data from the wired remote controller sold separately in the set data “0000”.

- Select by exchange of short plug on indoor microcomputer P.C. board.

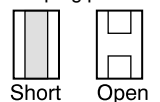
- Short plug position (CN112, CN111, CN110 from the left)

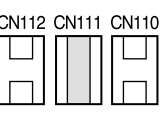
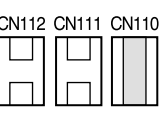
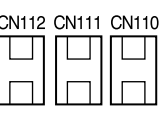
Short plug position	Set data	Filter sold separately
 Short      Open		
CN112 CN111 CN110 	0000	Standard filter (At shipment)
CN112 CN111 CN110 	0001	Never execute such a change of the short plug as shown at the left; otherwise a malfunction may be caused.
CN112 CN111 CN110 	0003	
CN112 CN111 CN110 	0006	

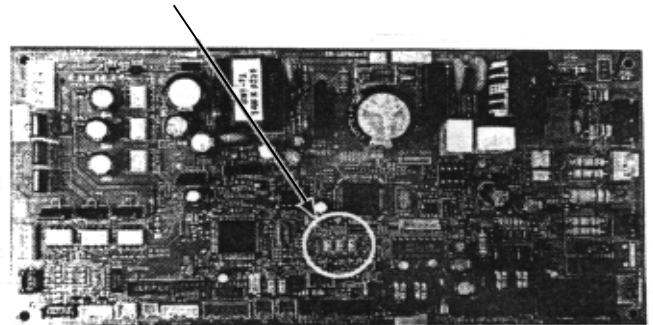

## 8 APPLICABLE CONTROLS

### Change of lighting time of filter sign

According to the installation condition, the lighting time of the filter sign (Notification of filter cleaning) can be changed.

Follow to the basic operation procedure

(**1** → **2** → **3** → **4** → **5** → **6**).

- For the item code in Procedure **3**, specify [01].
- For the set data in Procedure **4**, select the setup data of lighting time of filter sign to be changed from the table below.

Set data	Filter sign lighting time
0000	None
0001	150H
0002	2500H (At shipment)
0003	5000H
0004	10000H

### To secure better effect of heating

When it is difficult to obtain satisfactory heating due to installation place of the indoor unit or structure of the room, the detection temperature of heating can be raised. Also use a circulator, etc. to circulate heat air near the ceiling.

Follow to the basic operation procedure

(**1** → **2** → **3** → **4** → **5** → **6**).

- For the item code in Procedure **3**, specify [06].
- For the set data in Procedure **4**, select the setup data of shift value of detection temperature to be set up from the table below.

Set data	Shift value of detection temp.
0000	No shift
0001	+1°C
0002	+2°C (At shipment)
0003	+3°C
0004	+4°C
0005	+5°C
0006	+6°C



## Group control

### Simultaneous twin system

If combining with an outdoor unit, ON/OFF operation of two indoor units is simultaneously available for the twin system.

- For wiring procedure and wiring method, follow to the "Electric work" in this manual.
- When the power supply has been turned on, the automatic address setup starts and " " display which indicates that address is being set up flashes on the display part. During setup of automatic address, the remote controller operation is not accepted.

Required time up to the finish of automatic addressing is approx. 5 minutes.

### <Twin system>

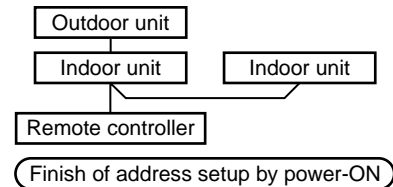

### In case of group control for system of multiple units

One remote controller can control maximum 8 indoor units as a group.

#### <In case of group control in single system>

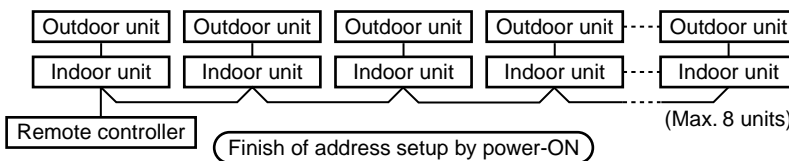

### NOTE

In some cases, it is necessary to change the address manually after setup of the automatic address according to the system configuration of the group control.

- The above-mentioned system configuration is a case when complex systems in which systems of the multiple twin unit is controlled as a group by a remote controller.

- For wiring procedure and wiring method of the individual line (Identical refrigerant line) system, follow to "Electric work".
- Wiring between lines is performed in the following procedure. Connect the terminal block (A/B) of the indoor unit connected with a remote controller to the terminal blocks (A/B) of the indoor units of other indoor units by wiring the inter-unit wire of the remote controller.
- When the power supply has been turned on, the automatic address setup starts and " " display which indicates that address is being set up flashes on the display part. During setup of automatic address, the remote controller operation is not accepted.

Required time up to the finish of automatic addressing is approx. 5 minutes.

### (Example) Group control for complex system

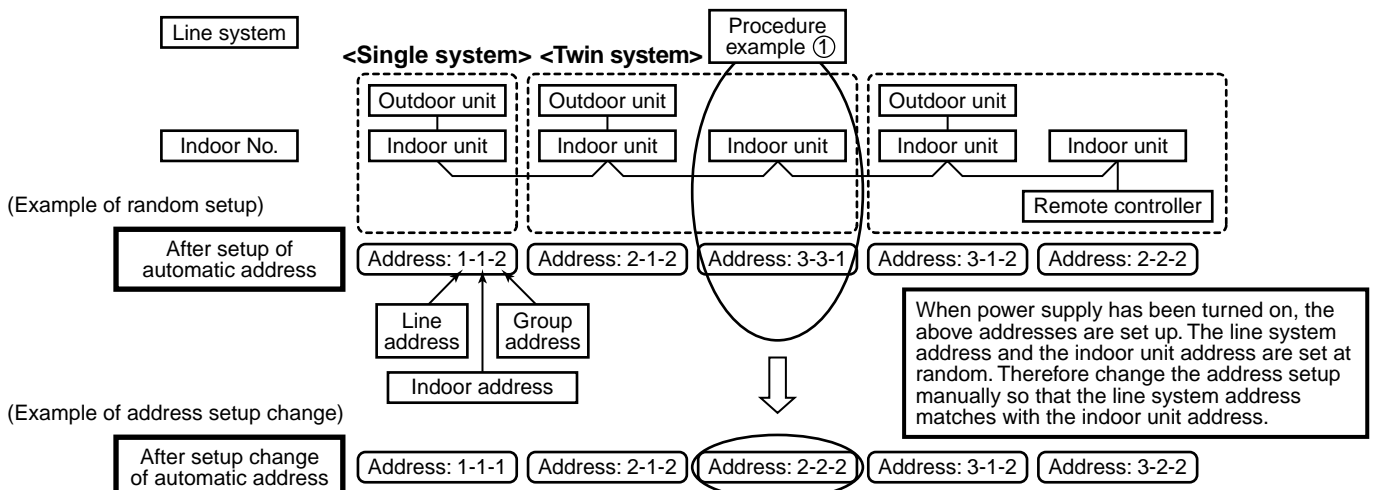





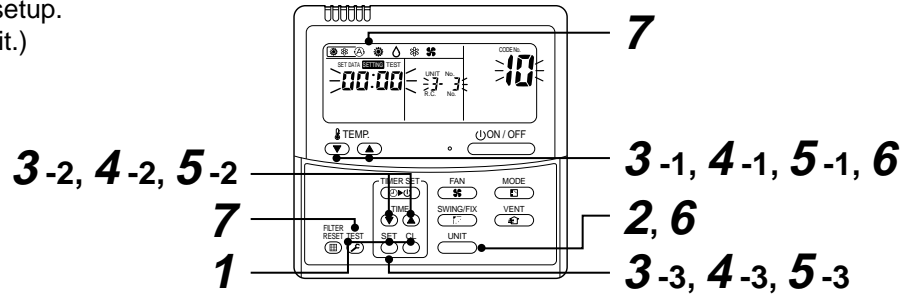

# 8 APPLICABLE CONTROLS

## Procedure example ① Manual address setup procedure

While the operation stops, change the setup.  
(Be sure to stop the operation of the unit.)

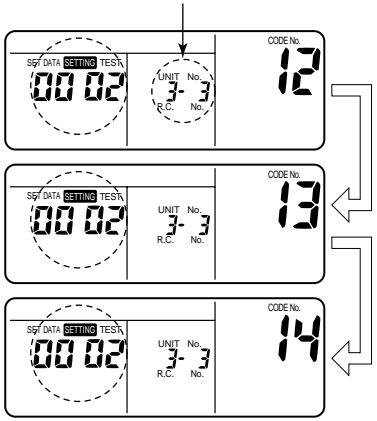



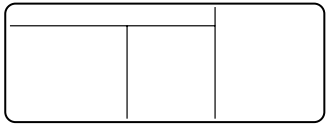



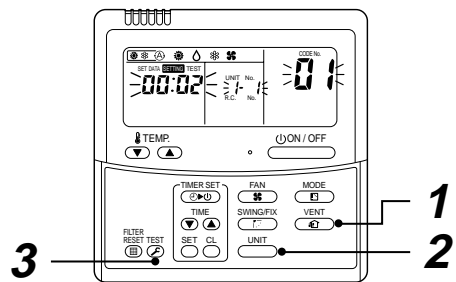

Procedure	Description
<b>1</b>	<p>Push simultaneously <b>SET</b> + <b>CL</b> + <b>TEST</b> buttons for 4 seconds or more. After a while, the display part flashes as shown below. Check the displayed ITEM CODE is [10].</p> <ul style="list-style-type: none"> <li>When the ITEM CODE is other than [10], push <b>TEST</b> button to erase the display and repeat procedure from the first step. (After pushing <b>TEST</b> button, operation of the remote controller is not accepted for approx. 1 minute.) (For a group control, No. of the firstly displayed indoor unit becomes the header unit.)</li> </ul>
<b>2</b>	<p>Every pushing <b>UNIT</b> button, the indoor unit No. in the group control is displayed in order. Select the indoor unit of which setup is changed.</p> <p>In this time, the position of the indoor unit of which setup is changed can be confirmed because fan and flap of the selected indoor unit operate.</p>
<b>3-1</b>	<p>Using temp. setup <b>▼</b> / <b>▲</b> buttons, specify ITEM CODE [12]. (ITEM CODE [12]: Line address)</p> <p style="text-align: right;">Indoor unit No. before setup change is displayed.</p>
<b>3-2</b>	<p>Using timer time <b>▼</b> / <b>▲</b> buttons, change the line address from [3] to [2].</p>
<b>3-3</b>	<p>Push <b>SET</b> button.</p> <p>In this time, the setup finishes when the display changes from flashing to lighting.</p>
<b>4-1</b>	<p>Using temp. setup <b>▼</b> / <b>▲</b> buttons, specify ITEM CODE [13]. (ITEM CODE [13]: Indoor address)</p> <p style="text-align: right;">Indoor unit No. before setup change is displayed.</p>
<b>4-2</b>	<p>Using timer time <b>▼</b> / <b>▲</b> buttons, change the indoor address from [3] to [2].</p>
<b>4-3</b>	<p>Push <b>SET</b> button.</p> <p>In this time, the setup finishes when the display changes from flashing to lighting.</p>
<b>5-1</b>	<p>Using temp. setup <b>▼</b> / <b>▲</b> buttons, specify ITEM CODE [14]. (ITEM CODE [14]: Group address)</p> <p style="text-align: right;">Indoor unit No. before setup change is displayed.</p>
<b>5-2</b>	<p>Using timer time <b>▼</b> / <b>▲</b> buttons, change the setup data from [0001] to [0002]. (Setup data [Header unit: 0001] [Follower unit: 0002])</p>
<b>5-3</b>	<p>Push <b>SET</b> button.</p> <p>In this time, the setup finishes when the display changes from flashing to lighting.</p>

Procedure	Description
6	<p>If there is other indoor unit to be changed, repeat procedure <b>2</b> to <b>5</b> to change the setup.</p> <p>When the above setup has finished, push  to select the indoor unit No. before change of setup, specify ITEM CODE [12], [13], [14] in order with temp. setup  /  buttons, and then check the changed contents.</p> <p>Address change check Before change: [3-3-1] → After change: [2-2-2]</p> <p>Pushing CL button clears the contents of which setup was changed. (In this case, procedure from <b>2</b> is repeated.)</p> <p>Indoor unit No. before setup change is displayed.</p> 
7	<p>After check of the changed contents, push  button. (Setup is determined.) When pushing  button, the display disappears and the status becomes the usual stop status. (When pushing  button the operation from the remote controller is not accepted for approx. 1 minute.)</p> <p>* If the operation from the remote controller is not accepted even 1 minute or more passed after pushing  button, it is considered that the address setup is incorrect. In this case, the automatic address must be again set up. Therefore repeat procedure of the setup change from the Procedure <b>1</b>.</p> 

**To recognize the position of the corresponding indoor unit though the indoor unit No. is known**

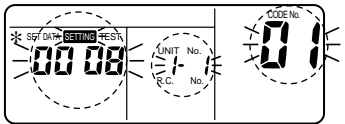

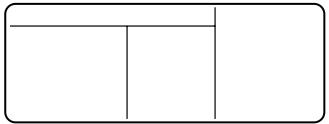

Check the position during operation stop.  
(Be sure to stop operation of the set.)





Procedure	Description
1	<p>Push simultaneously  +  buttons for 4 seconds or more. After a while, the display part flashes and the display appears as shown below. In this time, the position can be checked because fan and flap of the indoor unit operate.</p> <ul style="list-style-type: none"> <li>For the group control, the indoor unit No. is displayed as [ALL] and fans and flaps of all the indoor units in the group control operate.</li> </ul> <p>Check the displayed ITEM CODE is [01].</p> <ul style="list-style-type: none"> <li>When the ITEM CODE is other than [01], push  button to erase the display and repeat procedure from the first step. (After pushing  button, operation of the remote controller is not accepted for approx. 1 minute.)</li> </ul>  <p>(* Display changes according to the model No. of indoor unit.)</p>
2	<p>In the group control, every pushing  button, the indoor unit No. in the group control is displayed in order. In this time, the position of the indoor unit can be confirmed because only fan and flap of the selected indoor unit operate. (For a group control, No. of the firstly displayed indoor unit becomes the header unit.)</p>
3	<p>After confirmation, push  button to return the mode to the usual mode.</p> <p>When pushing  button, the display disappears and the status becomes the usual stop status. (When pushing  button the operation from the remote controller is not accepted for approx. 1 minute.)</p> 

# 9 INSTALLATION/SERVICING TOOLS

## Tools

Tools	Applicable to R22 model	
Gauge manifold	<input type="checkbox"/>	
Charge hose	<input type="checkbox"/>	
Electronic balance for refrigerant charging	<input type="radio"/>	
Torque wrench (nominal diam. 1/4, 3/8, 1/2, 5/8)	<input type="checkbox"/>	

Tools	Applicable to R22 model	
Flare tool (clutch type)	<input type="radio"/>	
Gauge for projection adjustment	—	—
Vacuum pump adapter	<input type="radio"/>	
Gas leak detector	<input type="checkbox"/>	

○ : Newly prepared (They are special requirements for R407C, separate from those for R22.)

□ : Existing tools are available.

For the details of the tools, refer to the Installation manual of the outdoor unit.

# 10 MAINTENANCE

## Cleaning of Return grille

### Preparation :

1. Turn off the main power supply switch (or breaker) before the unit maintenance.
2. Dismount the Suction grille.

### Clean the Return grilles with water:

- Wipe down the Suction grille with a sponge or towel moistened with a kitchen detergent. (Do not use any metallic brush for cleaning.)
- **Carefully rinse the Return grille to wash out the detergent.**
- **After rinsing the Return grille with water, dry it in the shade.**

### CAUTION

- Do not start the air conditioner while leaving the return grille removed.

## Cleaning of Air Filters

- If the air filters are not cleared, it not only impairs the cooling performance of air conditioner but causes a failure in the air conditioner such as water drops.

### Preparation :

1. Turn off the main power supply switch (or breaker) before the unit maintenance.
2. Dismount the Return grille.

### Removal of suction grille

Slide the suction grille fixing knobs (two positions) toward the arrow direction, and then open the suction grille.

Under the condition of suction grille opened, push the hook section of hinges (two positions) at the rear side, and then pull out the suction grille.

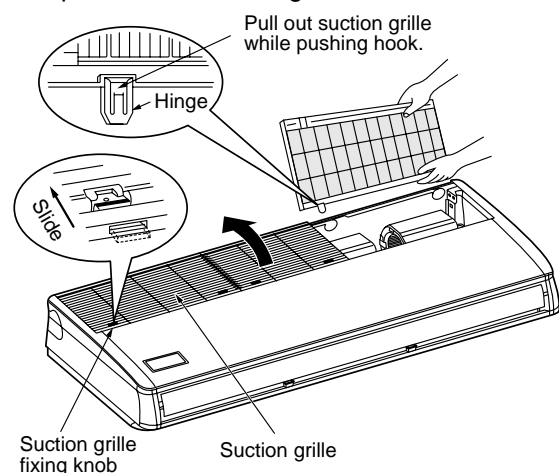

## Cleaning of air filter

- [FILTER] is displayed on the remote controller, maintain the air filter.
- Clogging of the air filter decreases the cooling/heating effect.

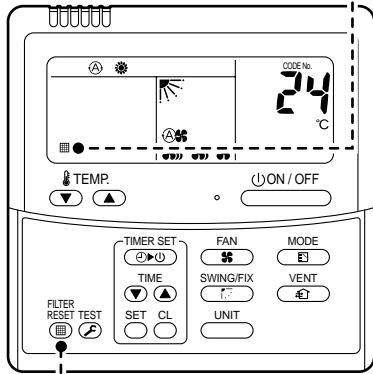

- After cleaning, push [  ].
- [FILTER] display disappears.

### 1 Open the suction grille

- Hold "Knob" of the suction grille, push it backward (OPEN), and then open the suction grille softly while holding the suction grille.

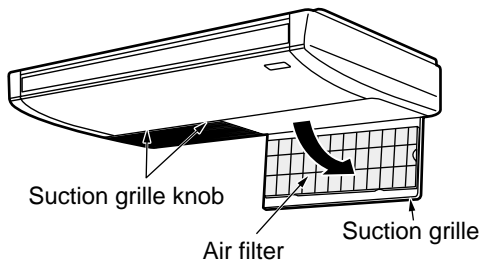

### 2 Take out air filter.

- Push the handle of the air filter, and remove the hook of the suction grille. Pull out the air filter toward you.

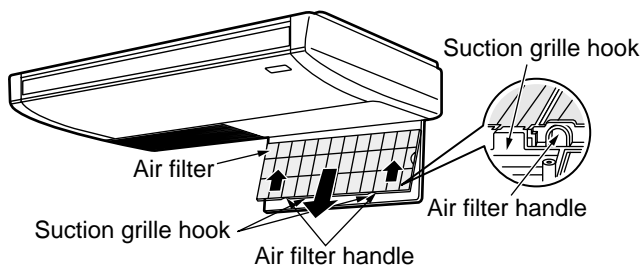

### 3 Soak up dust with a cleaner or clean with wash.

- If dust is heavy, wash it with tepid water including neutral detergent or water.

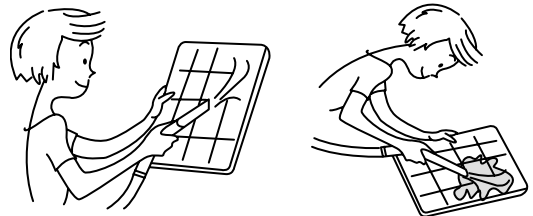

- After cleaning with water, dry it completely in the shade.

### 4 Mount the air filter.

### 5 Close the suction grille.

- Close the suction grille, and then fix it securely while sliding [knob] toward you.

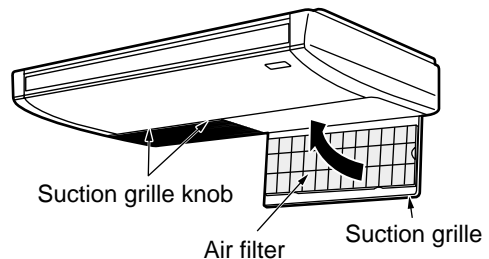

### 6 Push [ ].

- [FILTER] display disappears.

This product is compliant with Directive 2002/95/EC, and cannot be disposed as unsorted municipal waste.

Ce produit est conforme à la Directive 2002/95/CE et il ne peut pas être jeté avec les ordures ménagères non triées.

Dieses Produkt entspricht der Richtlinie 2002/95/EWG und darf nicht als normaler, unsortierter Hausabfall entsorgt werden.

Questo prodotto è conforme alla direttiva 2002/95/CE, e per disfarsene non deve essere gettato con la spazzatura della casa.

Este producto cumple con la Directiva 2002/95/EC, y no se puede desechar como la basura municipal.

Este produto respeita a Directiva 2002/95/EC e não pode ser deitado fora como lixo municipal.

Dit product is in overeenstemming met richtlijn 2002/95/EC en mag niet als huishoudelijk afval worden afgevoerd.

Το προϊόν αυτό συμμορφώνεται με την Οδηγία 2002/95/ΕΕ και δεν μπορεί να απορριφτεί ως μη ταξινομημένο δημοτικό απόβλητο.