

TOSHIBA

AIR CONDITIONER (SPLIT TYPE)
CLIMATISEUR (TYPE SPLIT)
KLIMAGERÄT (SPLIT-SYSTEM)
CONDIZIONATORE D'ARIA (TIPO SCOMPONIBILE)
APARATO DE AIRE ACONDICIONADO (TIPO SPLIT)
AR CONDICIONADO (TIPO SPLIT)
AIRCONDITIONER (GESPLITST TYPE)
ΚΛΙΜΑΤΙΣΤΙΚΟ ΜΗΧΑΝΗΜΑ (ΔΙΑΙΡΟΥΜΕΝΟΣ ΤΥΠΟΣ)

OWNER'S MANUAL
MANUEL DU PROPRIETAIRE
BETRIEBSANLEITUNG
MANUALE DEL PROPRIETARIO
MANUAL DEL PROPIETARIO
MANUAL DO UTILIZADOR
GEBRUIKSAANWIJZING
ΟΔΗΓΙΕΣΧΡΗΣΗΣ

<Under Ceiling/Console Type>/<Type Sous Plafond/Console>
<Unterdecken-/Konsolenmodell>/<Tipo a Soffitto/Console>
<Tipo Instalación en Techo/Consola>/<Sob Tecto/Tipo de Consola>
<Plafond-/Consoletype>/<Τυπος Για Τοποθετηση Κατω Απο Την Οροφη/Κονσολα>

Heat Pump Model/Modèle à thermopompe
Geräte mit Heizung/Modello con pompa di riscaldamento
Modelo con bomba de calor/Modello de bomba térmica
Model met warmtemomp/Μοντέλο με Αντλία Θερμότητας

Indoor Unit/Unité intérieure
Raumeinheit/Unità interna
Unidad interior/Unidade interior
Binnenunit/Εσωτερική Μονάδα

Outdoor Unit/Unité extérieure
Außengerät/Unità esterna
Unidad exterior/Unidade exterior
Buitenunit/Εξωτερική Μονάδα

RAV-SM562XT-E
RAV-SM802XT-E

RAV-SM562AT-E
RAV-SM802AT-E



Thank you very much for purchasing TOSHIBA Air Conditioner.

Please read this owner's manual carefully before using your Air Conditioner.

• Be sure to obtain the "Owner's manual" and "Installation manual" from constructor (or dealer).

Request to constructor or dealer

Please clearly explain the contents of the Owner's manual and hand over it.

Nous vous remercions pour avoir choisi un climatiseur TOSHIBA.

Veuillez lire attentivement ce Manuel du propriétaire avant d'utiliser votre climatiseur.

• Assurez-vous que le constructeur (ou le revendeur) vous remette le "Manuel du propriétaire" et le "Manuel d'installation".

Demande au constructeur ou au revendeur

Veuillez expliquer clairement le contenu du Manuel du propriétaire et le remettre au client.

Wir danken Ihnen, dass Sie sich für ein TOSHIBA Klimagerät entschieden haben.

Bitte lesen Sie diese Betriebsanleitung, bevor Sie Ihr Klimagerät benutzen, sorgfältig.

• Lassen Sie sich die "Betriebsanleitung" und das "Installations-Handbuch" unbedingt vom Installateur oder vom Lieferanten aushändigen.

Eine Bitte an den Installateur oder Lieferanten:

Bitt erklären Sie dem Käufer den Inhalt der Betriebsanleitung und händigen sie ihm aus.

Grazie di aver acquistato un condizionatore d'aria TOSHIBA.

Prima di usare il condizionatore d'aria, leggere con attenzione questo manuale del proprietario.

• Si raccomanda di tenere a portata di mano il "Manuale del proprietario" e il "Manuale di installazione" ricevuti dal produttore (o dal rivenditore).

Richiesta al produttore o al rivenditore

Spiegare chiaramente il contenuto del Manuale del proprietario e consegnarne una copia all'utente.

Muchas gracias por haber adquirido el aparato de aire acondicionado TOSHIBA.

Lea atentamente este manual del propietario antes de utilizar el aparato de aire acondicionado.

• Asegúrese de que el fabricante (o distribuidor) le proporcione el "Manual del propietario" y el "Manual de instalación".

Solicitud al fabricante o distribuidor

Explique con claridad el contenido del Manual del propietario y entréguelo al cliente.

Muito obrigada por adquirir o Ar Condicionado TOSHIBA.

Leia atentamente este manual do utilizador antes de utilizar o seu ar condicionado.

• Não se esqueça de receber o "Manual so utilizador" e o "Manual de inslatação" do fabricante (ou agente).

Pedido ao fabricante ou agente

Explique por favor o conteúdo do Manual so utilizador e entregue-o.

Hartelijk dank voor uw keuze voor een airconditioner van TOSHIBA.

Lees deze gebruiksaanwijzing zorgvuldig door voordat ude airconditioner gaat gebruiken.

• Zorg ervoor dat u zowel de 'gebruiksaanwijzing' als de 'installatiehandleiding' van de installateur (of leverancier) krijgt.

Verzoek aan de installateur of de leverancier

Leg de inhoud van de gebruiksaanwijzing duidelijk uit en overhandig de gebruiksaanwijzing nadien aan de klant.

Σας ευχαριστούμε πολύ που προτιμήσατε για την αγορά σας ένα Κλιματιστικό TOSHIBA.

Παρακαλούμε διαβάστε προσεκτικά τις οδηγίες χρήσης πριν από τη χρήση του Κλιματιστικού.

• Βεβαιωθείτε ότι ο κατασκευαστής (ή ο πωλητής) σας παρέδωσε και τις "Οδηγίες Χρήσης" και το "Εγχειρίδιο Εγκατάστασης".

Παράκληση για τον κατασκευαστή ή τον πωλητή

Παρακαλώ εξηγήστε με σαφήνεια τα περιεχόμενα των Οδηγιών Χρήσης και παραδώστε το.

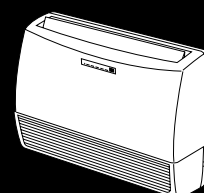
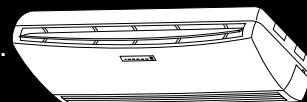

This product is compliant with Directive 2002/95/EC, and cannot be disposed as unsorted municipal waste.

Cet article est conforme à la Directive 2002/95/CE et doit être éliminé à travers la collecte sélective.

Dieses Produkt entspricht der Richtlinie 2002/95/EC und muss als Sondermüll behandelt werden.

Questo prodotto è conforme alla direttiva 2002/95/CE e non può essere smaltito utilizzando la generica raccolta rifiuti da parte della municipalizzata.

Este producto cumple con las especificaciones de la directiva 2002/95/CE, y no se puede desechar como residuo doméstico no clasificado.

Este produto cumpre a Directiva 2002/95/CE e não pode ser descartado como resíduo municipal não tratado.

Dit product voldoet aan de richtlijn 2002/95/EC en mag niet afgevoerd worden als ongesorteerd huishoudelijk afval.

Αυτό το προϊόν είναι συμβατό με την Οδηγία 2002/95/EC, και δεν μπορεί να απορριφθεί μαζί με τα μη ταξινομημένα δημοτικά απόβλητα.

ADOPTION OF NEW REFRIGERANT

This Air Conditioner is a new type which adopts a new refrigerant HFC (R410A) instead of the conventional refrigerant R22 in order to prevent destruction of the ozone layer.

UTILISATION DU NOUVEAU REFRIGERANT

Ce climatiseur est d'un type inédit qui utilise le nouveau réfrigérant HFC (R410A) au lieu du réfrigérant traditionnel R22, afin d'éviter la destruction de la couche d'ozone.

EINFÜHRUNG EINES NEUEN KÜHLMITTELS

Dies ist ein neuartiges Klimagerät. Anstatt des herkömmlichen Kühlmittels R22 verwendet es das neue ozonschichtschonende HFC Kühlmittel R410A.

ADOZIONE DI UN NUOVO REFRIGERANTE

Questo condizionatore d'aria è di un tipo nuovo che adotta un nuovo refrigerante HFC (R410A) al posto del refrigerante convenzionale R22, per prevenire la distruzione dello strato di ozono dell'atmosfera terrestre.

ADOPCIÓN DE NUEVO REFRIGERANTE

Este aparato de aire acondicionado es un modelo reciente que incorpora el nuevo refrigerante HFC (R410A) en lugar del refrigerante convencional R22 para así evitar daños en la capa de ozono.

ADOPÇÃO DO NOVO REFRIGERANTE

Este ar condicionado é um modelo novo que adota um novo refrigerante HFC (R410A) em vez do refrigerante convencional R22 para evitar a destruição da cama de ozono.

TOEPASSING VAN EEN NIEUW KOELMIDDEL

Deze airconditioner is een nieuwe type dat werkt met een nieuw koelmiddel HFC (R410A) in plaats van met het conventionele koelmiddel R22, als bijdrage om de aantasting van de ozonlaag te reduceren.

ΥΙΟΘΕΤΗΣΗ ΝΕΟΥ ΨΥΚΤΙΚΟΥ

Το παρόν Κλιματιστικό είναι νέος τύπος που υιοθετεί νέο ψυκτικό HFC (R410A) στη θέση του συμβατικού ψυκτικού R22 προκειμένου να βοηθήσει στην προστασία του όζοντος.

CONTENTS

ACCESSORIES/AIR FILTER COMPONENTS	1	HIGH POWER OPERATION	10
PRECAUTIONS FOR SAFETY	1	TIMER OPERATION	10
PARTS NAME	3	MEMORY/PRESET OPERATION	12
NAMES AND FUNCTIONS OF INDICATORS AND CONTROLS ON INDOOR UNIT	3	ADJUSTING AIR FLOW DIRECTION	13
REMOTE CONTROLLER AND ITS FUNCTIONS	4	AUTO RESTART OPERATION	14
NAMES AND FUNCTIONS OF INDICATIONS ON REMOTE CONTROLLER	5	HOW THE AIR CONDITIONER WORKS	15
PREPARATION AND CHECK BEFORE USE	5	TEMPORARY OPERATION	16
HANDLING THE REMOTE CONTROLLER	7	MAINTENANCE	17
AUTOMATIC OPERATION	8	AIR CONDITIONER OPERATIONS AND PERFORMANCE	19
AUTOMATIC OPERATION (AUTO CHANGEOVER)	8	TROUBLES AND CAUSES	20
COOLING/HEATING/FAN ONLY OPERATION	9	SPECIFICATIONS	22
DRY OPERATION	9	TROUBLES AND CAUSES (Concerning Remote Controller)	23

SOMMAIRE

ACCESSOIRES/COMPOSANTS DU FILTRE A AIR	25	DESHUMIDIFICATION	33
MESURES DE SECURITE	25	MODE HIGH POWER	34
NOM DES PIECES	27	MODE MINUTERIE	34
NOM ET FONCTION DES INDICATEURS ET COMMANDES DE L'UNITE INTERIEURE	27	MODE MEMOIRE/PREREGLAGE	36
LA TELECOMMANDE ET SES FONCTIONS	28	REGLAGE DU SENS DU FLUX D'AIR	37
NOMS ET FONCTIONS DES INDICATIONS DE LA TELECOMMANDE	29	FONCTION DE REDEMARRAGE AUTOMATIQUE	38
PREPARATION ET VERIFICATION AVANT UTILISATION	29	MODE DE FONCTIONNEMENT DU CLIMATISEUR	39
MANIPULATION DE LA TELECOMMANDE	31	FONCTIONNEMENT TEMPORAIRE	40
FONCTIONNEMENT AUTOMATIQUE	32	MAINTENANCE	41
FONCTIONNEMENT AUTOMATIQUE (PERMUTATION AUTOMATIQUE)	32	FONCTIONNEMENT ET PERFORMANCES DU CLIMATISEUR	43
REFROIDISSEMENT/CHAUFFAGE/VENTILATEUR SEUL	33	PROBLEMES ET CAUSES	44
		DONNÉES TECHNIQUES	46
		PROBLEMES ET CAUSES (Concernant la Télécommande)	47

INHALT

ZUBEHÖR/BESTANDTEILE DES LUFTFILTERS	49	ENTFEUCHTUNGS-BETRIEB	57
SICHERHEITSVORKEHRUNGEN	49	HOCHLEISTUNGSBETRIEB	58
TEILEBEZEICHNUNG	51	TIMERBETRIEB	58
BEZEICHNUNGEN UND FUNKTIONEN DER ANZEIGEN UND REGLER AM RAUMGERÄT	51	SPEICHERBETRIEB	60
DIE FERNBEDIENUNG UND IHRE FUNKTIONEN	52	REGULIERUNG DER LUFTSTROMRICHTUNG	61
BEZEICHNUNG UND FUNKTION DER ANZEIGEN AUF DER FERNBEDIENUNG	53	AUTOMATISCHER NEUSTART	62
VORBEREITUNGEN UND ÜBERPRÜFUNGEN VOR DEM BETRIEB	53	WIE DIE KLIMAAANLAGE FUNKTIONIERT	63
HANDHABUNG DER FERNBEDIENUNG	55	BETRIEB OHNE FERNBEDIENUNG (TEMPORARY)	64
AUTOMATIKBETRIEB	56	WARTUNGSHINWEISE	65
AUTOMATIKBETRIEB (AUTOMATISCHER BETRIEBSARTWECHSEL)	56	BETRIEB UND LEISTUNG DER KLIMAAANLAGE	67
KÜHL-/HEIZ-/NUR VENTILATOR - BETRIEB	57	STÖRUNGEN UND IHRE URSACHEN	68
		TECHNISCHE DATEN	70
		STÖRUNGEN UND IHRE URSACHEN (Betreffend die Fernbedienung)	71

INDICE

ACCESSORI/COMPONENTI DEI FILTRI DELL'ARIA	73	FUNZIONAMENTO HIGH POWER	82
PRECAUZIONI PER LA SICUREZZA	73	FUNZIONAMENTO DEL TIMER	82
NOMBRE DE LOS COMPONENTES	75	FUNZIONI MEMORY/PRESET	84
NOMI E FUNZIONI DEGLI INDICATORI E DEI COMANDI SULL'UNITÀ INTERNA	75	REGOLAZIONE DELLA DIREZIONE DEL FLUSSO D'ARIA	85
FUNZIONAMENTO DEL TELECOMANDO	76	FUNZIONE DI RIACCENSIONE AUTOMATICA (AUTO RESTART)	86
NOMI E FUNZIONI DELLE INDICAZIONI SUL TELECOMANDO	77	MODI DI FUNZIONAMENTO DEL CONDIZIONATORE D'ARIA	87
OPERAZIONI PRELIMINARI E CONTROLLO PRIMA DELL'USO	77	FUNZIONAMENTO TEMPORANEO	88
USO DEL TELECOMANDO	79	MANUTENZIONE	89
FUNZIONAMENTO AUTOMATICO	80	FUNZIONAMENTO E PRESTAZIONI DEL CONDIZIONATORE D'ARIA	91
FUNZIONAMENTO AUTOMATICO (COMMUTAZIONE AUTOMATICA)	80	PROBLEMI DI FUNZIONAMENTO E RELATIVE CAUSE	92
FUNZIONAMENTO DI RAFFREDDAMENTO/DI RISCALDAMENTO/ A SOLO VENTILATORE	81	CARATTERISTICHE TECNICHE	94
USO PER LA DEUMIDIFICAZIONE	81	PROBLEMI DI FUNZIONAMENTO (Del Telecomando) E RELATIVE CAUSE	95

CONTENIDO

ACCESORIOS/COMPONENTES DEL FILTRO DE AIRE	97	FUNCIONAMIENTO DE ALTA POTENCIA (HIGH POWER)	106
PRECAUCIONES SOBRE SEGURIDAD	97	FUNCIONAMIENTO DEL TEMPORIZADOR	106
NOMBRE DE LOS COMPONENTES	99	MEMORIA/FUNCIONAMIENTO PREDEFINIDO	108
NOMBRES Y FUNCIONES DE LOS INDICADORES Y CONTROLES DE LA UNIDAD INTERIOR	99	AJUSTE DE LA DIRECCIÓN DEL FLUJO DE AIRE	109
MANDO A DISTANCIA Y SUS FUNCIONES	100	FUNCIONAMIENTO DE REINICIO AUTOMÁTICO	110
NOMBRES Y FUNCIONES DE INDICACIONES DEL MANDO A DISTANCIA	101	CÓMO TRABAJA EL ACONDICIONADOR DE AIRE	111
PREPARATIVOS Y COMPROBACIONES PREVIAS	101	FUNCIONAMIENTO TEMPORAL	112
MANEJO DEL CONTROL REMOTO	103	MANTENIMIENTO	113
FUNCIONAMIENTO AUTOMÁTICO	104	FUNCIONAMIENTO Y RENDIMIENTO DEL ACONDICIONADOR DE AIRE	115
FUNCIONAMIENTO AUTOMÁTICO (AUTO CHANGEOVER)	104	PROBLEMAS Y CAUSAS	116
REFRIGERACIÓN/CALEFACCIÓN/VENTILACIÓN	105	ESPECIFICACIONES	118
FUNCIONAMIENTO DE DESHUMIDIFICACIÓN	105	PROBLEMAS Y CAUSAS (Relativas al Mando a distancia)	119

ÍNDICE

ACESSÓRIOS/COMPONENTES DO FILTRO DE AR	121	OPERAÇÃO DE ALTA POTÊNCIA	130
PRECAUÇÕES RELATIVAS A SEGURANÇA	121	OPERAÇÃO DO TEMPORIZADOR	130
DESIGNAÇÃO DAS PEÇAS	123	MEMÓRIA/OPERAÇÃO PRÉ CONFIGURADA	132
DESIGNAÇÃO E FUNÇÕES DOS INDICADORES E CONTROLOS DA UNIDADE INTERIOR	123	AJUSTE DA DIRECÇÃO DO FLUXO DE AR	133
COMANDO À DISTÂNCIA E RESPECTIVAS FUNÇÕES	124	FUNÇÃO DE REPOSIÇÃO EM MARCHA AUTOMÁTICA	134
DESIGNAÇÕES E FUNÇÕES DE INDICADORES DO COMANDO À DISTÂNCIA	125	COMO FUNCIONA O AR CONDICIONADO	135
PREPARAÇÃO E VERIFICAÇÃO ANTES DA UTILIZAÇÃO	125	FUNCIONAMENTO TEMPORÁRIO	136
UTILIZAÇÃO DO TELECOMANDO	127	MANUTENÇÃO	137
FUNCIONAMENTO AUTOMÁTICO	128	FUNCIONAMENTO E DESEMPENHO DO AR CONDICIONADO	139
FUNCIONAMENTO AUTOMÁTICO (AUTO CHANGEOVER)	128	PROBLEMAS E CAUSAS	140
MODO DE AQUECIMENTO/REFRIGERAÇÃO/VENTILAÇÃO	129	CARACTERÍSTICAS TÉCNICAS	142
FUNCIONAMENTO A SECO	129	PROBLEMAS E CAUSAS (relativos ao controlo remoto)	143

INHOUD

ACCESSOIRES/LUCHTFILTERCOMPONENTEN	145	DROGE WERKINGSSTAND (DRY)	153
VEILIGHEIDSVORZORGEN	145	WERKING MET HOOG VERMOGEN (HIGH POWER)	154
ONDERDELEN	147	TIMERGESTUURDE WERKING	154
BENAMING EN FUNCTIE VAN INDICATOREN EN BEDIENINGSELEMENTEN OP BINNENMODULE	147	GEHEUGEN-/VOORINTELWERKING	156
AFSTANDBEDIENING EN FUNCTIES	148	LUCHTSTROOM REGELEN	157
NAMEN EN FUNCTIES VAN AANDUIDINGEN OP DE AFSTANDBEDIENING	149	AUTOMATISCHE HERSTART	158
VOORBEREIDING EN CONTROLE VOORAF	149	WERKING VAN DE AIRCONDITIONING	159
BEHANDELING VAN DE AFSTANDBEDIENING	151	TEMPORARY FUNCTIE	160
AUTOMATISCHE WERKING	152	ONDERHOUD	161
AUTOMATISCHE WERKING (AUTOMATISCHE OMSCHAKELING)	152	WERKING EN PRESTATIES AIRCONDITIONING	163
KOELING/VERWARMING/VENTILATIE	153	PROBLEMEN EN OORZAKEN	164
		TECHNISCHE GEGEVENS	166
		PROBLEMEN EN OORZAKEN (betreffende afstandsbediening)	167

ΠΕΡΙΕΧΟΜΕΝΑ

ΕΞΑΡΤΗΜΑΤΑ/ΜΕΡΗ ΦΙΛΤΡΟΥ ΑΕΡΑ	169	ΛΕΙΤΟΥΡΓΙΑ HIGH POWER	178
ΠΡΟΦΥΛΑΞΕΙΣ ΑΣΦΑΛΕΙΑΣ	169	ΛΕΙΤΟΥΡΓΙΑ TIMER	178
ΟΝΟΜΑΤΟΛΟΓΙΑ ΕΞΑΡΤΗΜΑΤΩΝ	171	ΛΕΙΤΟΥΡΓΙΑ MEMORY/PRESET	180
ΟΝΟΜΑΤΑ ΚΑΙ ΛΕΙΤΟΥΡΓΙΕΣ ΤΩΝ ΕΝΔΕΙΞΕΩΝ ΚΑΙ ΧΕΙΡΙΣΤΗΡΙΩΝ ΤΗΣ ΕΣΩΤΕΡΙΚΗΣ ΜΟΝΑΔΑΣ	171	ΡΥΘΜΙΣΗ ΤΗΣ ΚΑΤΕΥΘΥΝΣΗΣ ΡΟΗΣ	181
ΤΟ ΤΗΛΕΧΕΙΡΙΣΤΗΡΙΟ ΚΑΙ ΟΙ ΛΕΙΤΟΥΡΓΙΕΣ ΤΟΥ	172	ΛΕΙΤΟΥΡΓΙΑ ΑΥΤΟΜΑΤΗΣ ΕΠΑΝΕΚΚΙΝΗΣΗΣ	182
ΟΝΟΜΑΤΑ ΚΑΙ ΛΕΙΤΟΥΡΓΙΕΣ ΤΩΝ ΕΝΔΕΙΞΕΩΝ ΤΟΥ ΤΗΛΕΧΕΙΡΙΣΤΗΡΙΟΥ	173	ΠΩΣ ΛΕΙΤΟΥΡΓΕΙ ΤΟ ΚΛΙΜΑΤΙΣΤΙΚΟ ΜΗΧΑΝΗΜΑ	183
ΠΡΟΕΤΟΙΜΑΣΙΑ ΚΑΙ ΕΛΕΓΧΟΣ ΠΡΙΝ ΑΠΟ ΤΗ ΧΡΗΣΗ	173	ΠΡΟΣΩΡΙΝΗ ΛΕΙΤΟΥΡΓΙΑ	184
ΧΕΙΡΙΣΜΟΣ ΤΟΥ ΤΗΛΕΧΕΙΡΙΣΤΗΡΙΟΥ	175	ΣΥΝΤΗΡΗΣΗ	185
ΑΥΤΟΜΑΤΗ ΛΕΙΤΟΥΡΓΙΑ	176	ΛΕΙΤΟΥΡΓΙΕΣ ΚΑΙ ΑΠΟΔΟΣΗ ΤΟΥ ΚΛΙΜΑΤΙΣΤΙΚΟΥ ΜΗΧΑΝΗΜΑΤΟΣ	187
ΑΥΤΟΜΑΤΗ ΛΕΙΤΟΥΡΓΙΑ (ΑΥΤΟΜΑΤΟΣ ΕΛΕΓΧΟΣ ΑΛΛΑΓΗΣ)	176	ΒΛΑΒΕΣ ΚΑΙ ΑΙΤΙΑ	188
ΛΕΙΤΟΥΡΓΙΑ ΨΥΞΗΣ/ΘΕΡΜΑΝΣΗΣ/ΜΟΝΟ ΑΝΕΜΙΣΤΗΡΑ	177	ΠΡΟΔΙΑΓΡΑΦΕΣ	190
ΛΕΙΤΟΥΡΓΙΑ ΑΦΥΓΡΑΝΣΗΣ	177	ΒΛΑΒΕΣ ΚΑΙ ΠΙΘΑΝΑ ΑΙΤΙΑ (Σχετικά με το τηλεχειριστήριο)	191

ACCESSORIES

AIR FILTER COMPONENTS

Remote controller

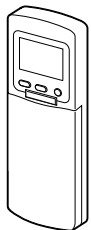

Remote controller holder

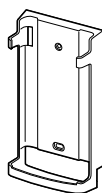

Batteries (two)

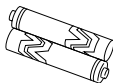

Filter frames (two)

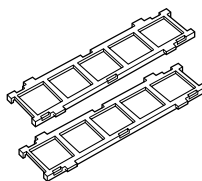

Sasa-Zeolite plus filter

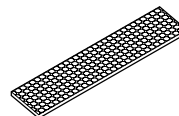

Bio-enzyme & Gingko filter

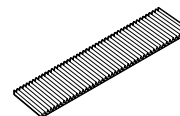

PRECAUTIONS FOR SAFETY

DANGER

- DO NOT ATTEMPT TO INSTALL THIS UNIT BY YOURSELF. THIS UNIT REQUIRES QUALIFIED INSTALLER.
- DO NOT ATTEMPT TO REPAIR THE UNIT BY YOURSELF. THIS UNIT HAS NO COMPONENTS WHICH YOU CAN REPAIR.
- OPENING OR REMOVING THE COVER WILL EXPOSE YOU TO DANGEROUS VOLTAGES.
- TURNING OFF THE POWER SUPPLY WILL NOT PREVENT POTENTIAL ELECTRIC SHOCK.

WARNING ⚠

WARNINGS ABOUT INSTALLATION

- Make sure to ask a dealer or a store specialized in electric work to install the air conditioner.
If the air conditioner is imperfectly installed by yourself, it may cause some problems such as water leak, electric shock, fire, and so on.
- Ground the air conditioner without fail.
Do not connect the ground wire to gas pipe, water pipe, lightning rod or ground wire of telephone. If the air conditioner is imperfectly grounded, it may cause electric shock.

CAUTION

TO DISCONNECT THE APPLIANCE FROM THE MAIN POWER SUPPLY
This appliance must be connected to the main power supply by means of a circuit breaker or a switch with a contact separation of at least 3 mm.
The installation fuse (25A D type ) must be used for the power supply line of this conditioner.

WARNINGS ABOUT OPERATION

- Avoid cooling the room too strong or exposing the human body to cool wind for a long time, because it is bad for the health.
- Do not insert fingers and sticks into the air outlet and air inlet to avoid getting injured and damaging the machine, because there are fans running at a high speed inside both the air inlet and air outlet.
- When you are aware of something abnormal with the air conditioner (smells something scorching, cools weak, etc.), immediately turn off the main switch, the circuit breaker, from the main power supply to stop the air conditioner, and make contact with the dealer.
If the air conditioner is continuously operated with something abnormal, it may cause machine failure, electric shock, fire, and so on.
- Do not spill water or other liquid on the indoor unit. If the unit is wet, it may cause an electric shock.

WARNINGS ABOUT MOVEMENT AND REPAIR

- Do not move nor repair any unit by yourself.
Since there is high voltage inside the unit, you may get an electric shock when removing the cover and main unit.
- Whenever the air conditioner needs repair, make sure to ask the dealer to do it. If it is repaired imperfectly, it may cause electric shock or fire.
- When moving the air conditioner for re-installing in another place, ask the dealer to do it. If it is imperfectly installed, it may cause electric shock or fire.

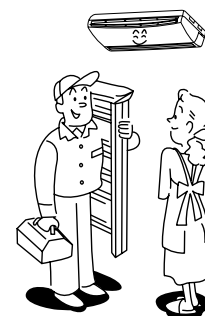
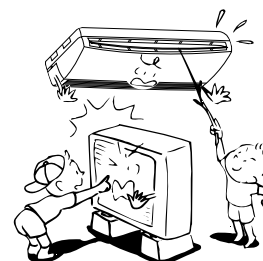
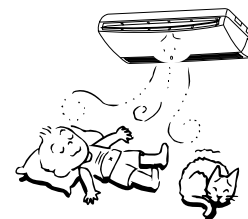

CAUTION

CAUTIONS ABOUT INSTALLATION

- Certainly lay the drain hose for perfect draining. Wrong drainage may cause flooding in the house and getting furniture wet.
- Make sure to connect the air conditioner to an exclusive power supply of the rated voltage; otherwise, the unit may break down or cause a fire.
- Do not install the unit in a place where inflammable gas may leak. If inflammable gas accumulates around the unit, it may cause a fire.

CAUTIONS ABOUT OPERATION

- Carefully read this manual before starting the air conditioner. The manual includes many important things for daily operation.
- Do not use this air conditioner for other purposes such as preserving food, precision instruments, art objects, breeding animals, growing potted plants, etc.
- Avoid exposing potted plants and animals to wind of the air conditioner, because it badly affects the health and growing of them.
- When the air conditioner is operated together with a combustion appliance in the same place, be careful of ventilation to let fresh air into the room. Poor ventilation causes oxygen shortage.
- When the air conditioner is used in a closed room, be careful of sufficient ventilation of the room. Poor ventilation causes oxygen shortage.
- Do not touch operation button with wet finger; otherwise, you may get an electric shock.
- Do not place any combustion appliance in a place where it is directly exposed to wind of the air conditioner; otherwise, it may cause imperfect combustion.
- When the air conditioner won't be used for a considerably long time, turn off the main switch or the circuit breaker, for safety. Disconnection from the power supply prevents the unit from lightning and power source surge.
- Check the concrete blocks, etc. underneath the outdoor unit occasionally. If the base is left damaged or deteriorated, the unit may topple over and inflict an injury on a person as the worst case.
- When cleaning the unit, make sure to turn off the main switch or circuit breaker beforehand for preventing you from getting injured by the electric fan running inside. For details of cleaning method, refer to "Maintenance" on page 17 and 18.
- Do not put a vessel with water such as a vase on the unit, because water may possibly sink into the unit and will bring about electric shock because of deterioration in electric insulation.
- Do not put anything on the outdoor unit or step onto it. If you do so, it may not only topple over the unit but also injure yourself.
- To make the air conditioner demonstrate its original performance, operate it within the range of the operating temperature specified in the instructions. Otherwise it may malfunction, break down or water may leak from the unit.
- Prevent any liquid from falling into the remote controller. Do not spill juice, water or any kind of liquid. (In case of Wireless Remote controller)

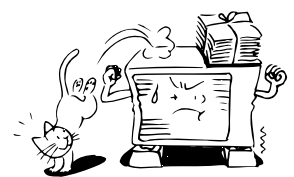
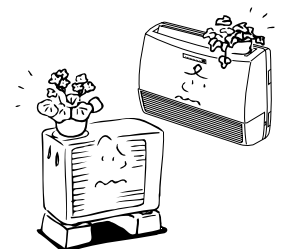
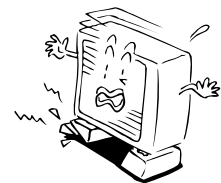
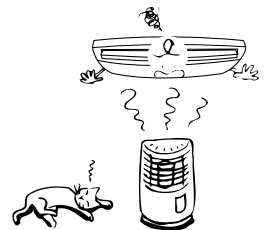
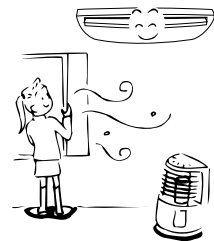
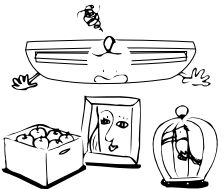
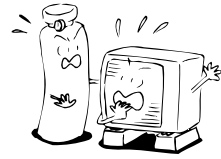
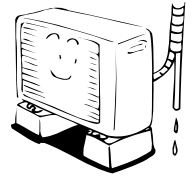

PARTS NAME

Outdoor unit

- (1) Air outlet (Blows off hot air during cooling or cool air during heating)
- (2) Power supply box (Contains electrical parts)
- (3) Earth screw (In the electrical parts box)
- (4) Refrigerant line connections

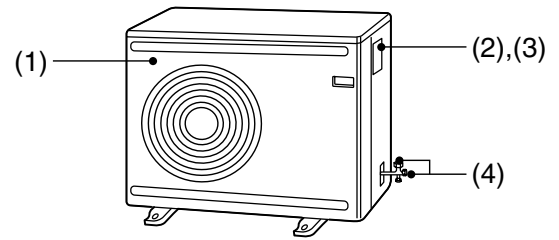

Indoor unit

- (5) Room temperature sensor
- (6) Front panel
- (7) Air inlet grille
- (8) Air filter
- (9) Air outlet
- (10) Horizontal air flow louver
- (11) Vertical air flow louver
- (12) Display panel
- (13) Infrared signal receiver
- (14) Remote controller

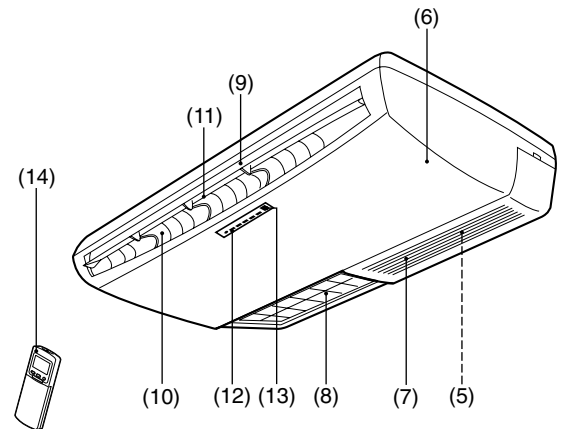

NAMES AND FUNCTIONS OF INDICATORS AND CONTROLS ON INDOOR UNIT

Display panel

The operating conditions are indicated below.

- (1) TEMPORARY button
- (2) Hi POWER lamp (Green)
- (3) FILTER lamp (Orange)
- (4) PRE.DEF lamp (Orange)
- (5) TIMER lamp (Yellow)
- (6) OPERATION lamp (Green/*Orange)

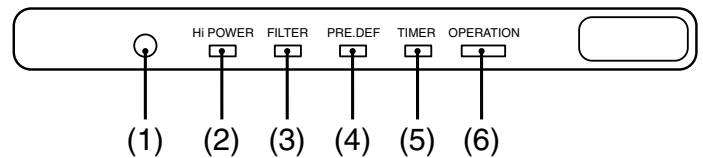

The operation lamps flash rapidly (five times per second), when safety protection features come into operation.

* When the auto restart function is in operation, the OPERATION lamp is orange.

TEMPORARY button

If you misplace or lose the remote controller or its batteries are exhausted, push the TEMPORARY button.

- Push the TEMPORARY button to start the air conditioner.
- Push this button once again to stop it.

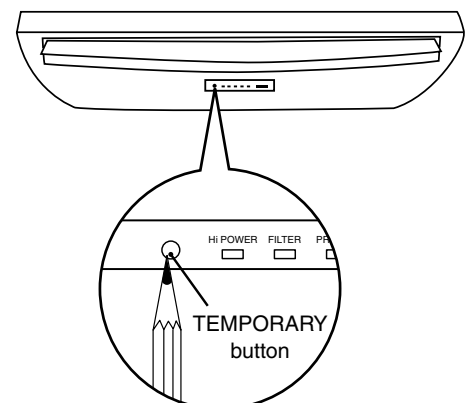

REMOTE CONTROLLER AND ITS FUNCTIONS

(1) Infrared signal emitter

Transmits a signal to the indoor unit.

(2) START/STOP button

Push the button to start operation.

(A receiving beep is heard.)

Push the button again to stop operation.

(A receiving beep is heard.)

If no receiving sound is heard from the indoor unit, push the button twice.

(3) Mode select button (MODE)

Push this button to select a mode.

Each time you push the button, a mode is selected in a sequence that goes from A : Auto changeover control, ☀ : Cool, ☹ : Dry,

☀ : Heat, ☹ : Fan only, and back to A.

(A receiving beep is heard.)

(4) Temperature button (▼ ▲)

▲ The set temperature is increased up to 30°C.

▼ The set temperature is dropped down to 17°C.

(A receiving beep is heard.)

(5) Fan speed button (FAN)

Push this button to select fan speed. When you select AUTO, the fan speed is automatically adjusted according to the room temperature.

You can also manually select the desired fan speed from among five settings.

(LOW ▬ , LOW+ ▬▬ , MED ▬▬▬ , MED+ ▬▬▬▬ , HIGH ▬▬▬▬▬)

(A receiving beep is heard.)

(6) Auto louver button (SWING)

Push this button to swing the louver.

(A receiving beep is heard.)

Push the SWING button to stop the louver swinging. (A receiving beep is heard.) (to see page 13.)

(7) Set louver button (FIX)

Push this button to adjust the air flow direction.

(A receiving beep is heard.)

While this button is kept depressed, the receiving tone continuously sounds. (to see page 13.)

(8) Off timer button (OFF)

Push this button to set the OFF timer.

(9) On timer button (ON)

Push this button to set the ON timer.

(10) Reserve button (SET)

Push this button to reserve time settings.

(A receiving beep is heard.)

(11) Cancel button (CLR)

Push this button to cancel ON timer and OFF timer. (A receiving beep is heard.)

(12) High power button (High POWER)

Push this button to start the high power operation. (to see page 10.)

(13) Memory button (MEMO)

Push this button to stand by memorizing the settings.

Push the button again for more than 3 seconds to memorize the setting indicated on the remote controller and **M** mark is indicated. (to see page 12.)

(14) Automatic operation button (AUTO)

Push this button to operate the air conditioner automatically.

(A receiving beep is heard.) (to see page 15.)

(15) ECO timer button (ECO)

Push this button to start the ECO timer (OFF timer) operation.

You can select the OFF timer time from among four settings (1, 3, 5 or 9 hours). (to see page 15.)

(16) FILTER button

Push this button to turn off the filter cleaning lamp on the indoor unit.

Push this button after cleaning the air filter. (to see page 17.)

(17) PRESET button

Push this button to operate the air conditioner according to settings memorized by the MEMO button. (to see page 12.)

(18) TIMER button

Use this button to change the clock, ON timer, and OFF timer times.

To forward the time, push the "TIMER " button.

To set back the time, push the "TIMER " button.

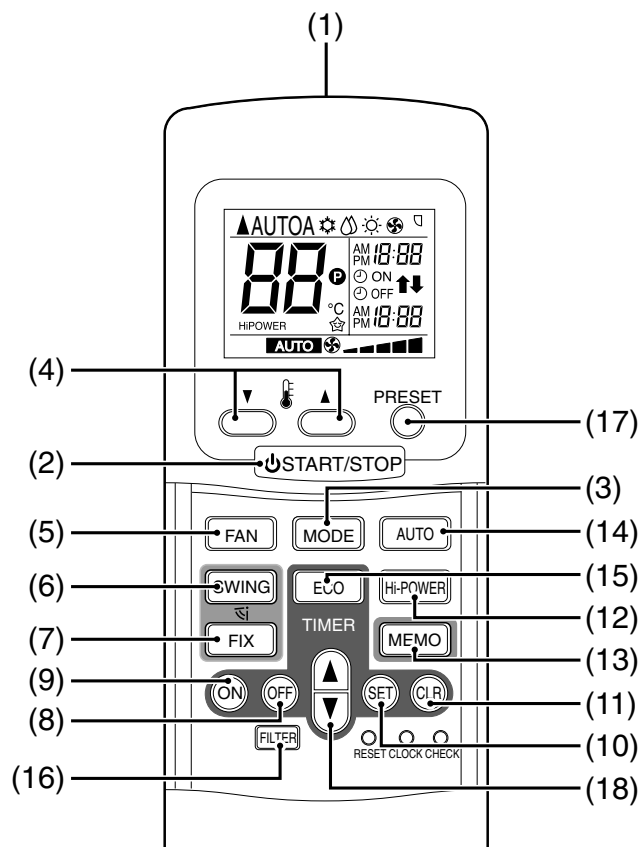

NAMES AND FUNCTIONS OF INDICATIONS ON REMOTE CONTROLLER

Display

All indications, except for clock time indication, are indicated by pushing the START/STOP button.

(1) Transmission mark

This transmission mark (▲) indicates when the remote controller transmits signals to the indoor unit.

(2) Mode display

Indicates the current operation mode.

(AUTO : Automatic control, A : Auto changeover control, ❄️ : Cool, 💧 : Dry, ☀️ : Heat, 🌀 : Fan only)

(3) Temperature display

Indicates the temperature setting (17°C to 30°C).

When you set the operating mode to 🌀 : Fan only, no temperature setting is indicated.

(4) FAN speed display

Indicates the selected fan speed. AUTO or one of five fan speed levels (LOW ▬, LOW+ ▬▬, MED ▬▬▬, MED+ ▬▬▬▬, HIGH ▬▬▬▬▬) can be indicated.

Indicates AUTO when the operating mode is either AUTO or 💧 : Dry.

(5) TIMER and clock time display

The time set for timer operation or clock time is indicated.

The present time is always indicated except for TIMER operation.

(6) Hi POWER display

Indicates when the Hi POWER operation starts.

Push the Hi POWER button to start and push it again to stop the operation.

(7) P (MEMORY) display

Flashes for 3 seconds when the MEMO button is pushed during operation.

P mark is indicated when keeping the button pushed for more than 3 seconds while the mark is flashing.

Push another button to turn off the mark.

(8) ECO TIMER display

Indicates when the ECO TIMER is in operation.

Each time you push the ECO button, the display changes in the sequence of 1, 3, 5 or 9h.

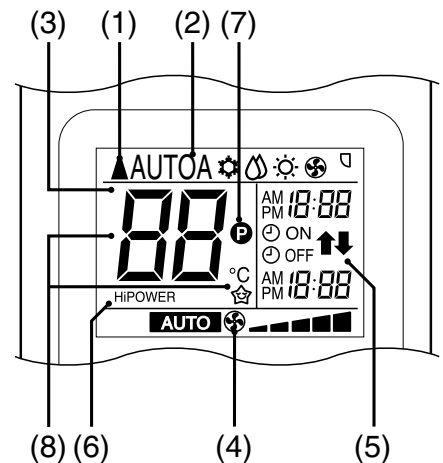

- In the illustration, all indications are indicated for explanation. During operation, only the relevant indications will be indicated on the remote controller.

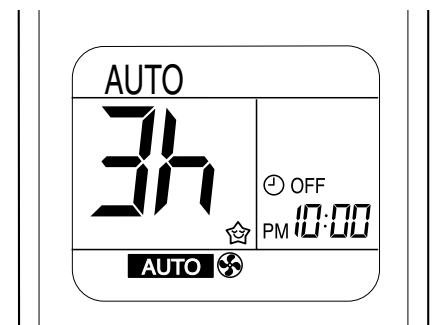

PREPARATION AND CHECK BEFORE USE

Loading the remote controller batteries.

(1) Remove the cover, and insert the batteries.

(2) Push the RESET button.

The clock display flashes.

Adjust the clock.

Place back the cover.

- Slide off the cover while pushing the sides.

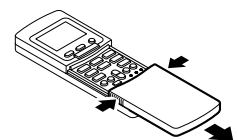

Battery replacement

Be careful not to reverse the (+) position and the (-) position.

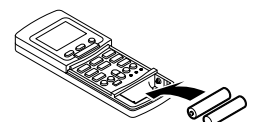

Batteries

- To replace the batteries, use two new batteries (AAA type).
- In normal use, the batteries will last about one year.
- Replace the batteries if there is no receiving beep from the indoor unit or when the air conditioner cannot be operated using the remote controller.
- To avoid malfunctions by battery leakage, remove the batteries when not using the remote controller for more than one month.

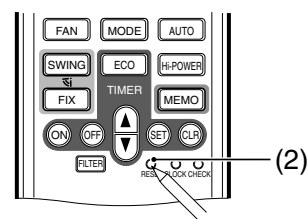

Setting the clock

Before you start operating the air conditioner, set the clock of the remote controller using the procedures given in this section. The clock panel on the remote controller will indicate the time regardless of whether the air conditioner is in use or not.

Initial setting

When batteries are inserted in the remote controller, the clock panel will indicate AM 0:00 and will flash.

(1) TIMER button

Push the TIMER  button to set the current time.

Each push of the TIMER button changes the time in one minute steps.

Pushing the TIMER button continually changes the time in ten minute steps.

(2) SET button

Push the SET  button.

The current time is indicated and the clock starts.

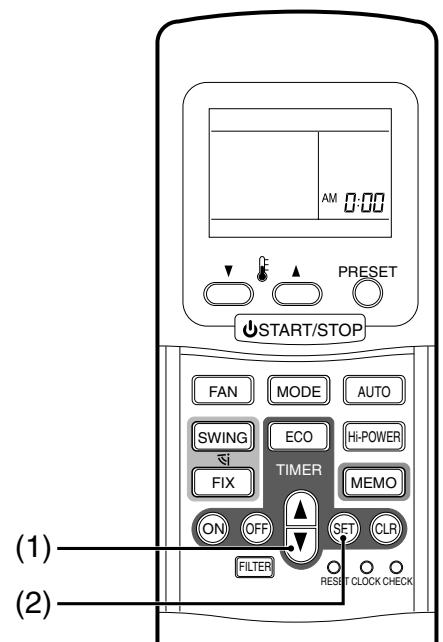

Clock adjusting

(1) CLOCK button

Push the CLOCK button.

The CLOCK display flashes.

(2) TIMER button

Push the TIMER  button to set the current time.

Each push of the TIMER button changes the time by one minute. Pushing the TIMER button continually changes the time by ten minutes.

(3) SET button

Push the SET  button.

The current time is indicated and the clock starts.

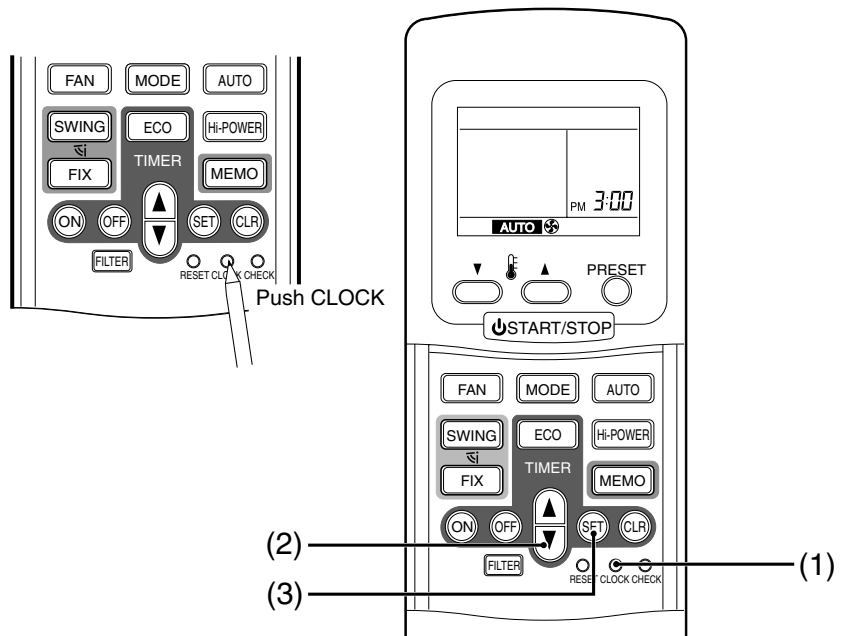

Preparing the filters

(1) Open the Air inlet grille with both hands until the stop position.

(2) Remove the Air filters from the Front panel.

(3) Install the Sasa-Zeolite plus filter and Bio-enzyme & Ginkgo filter in the Filter frame and then install it to the Air filters.

(4) Insert the Air filters in the Front panel and hook them into position.

(5) Close the Air inlet grille.

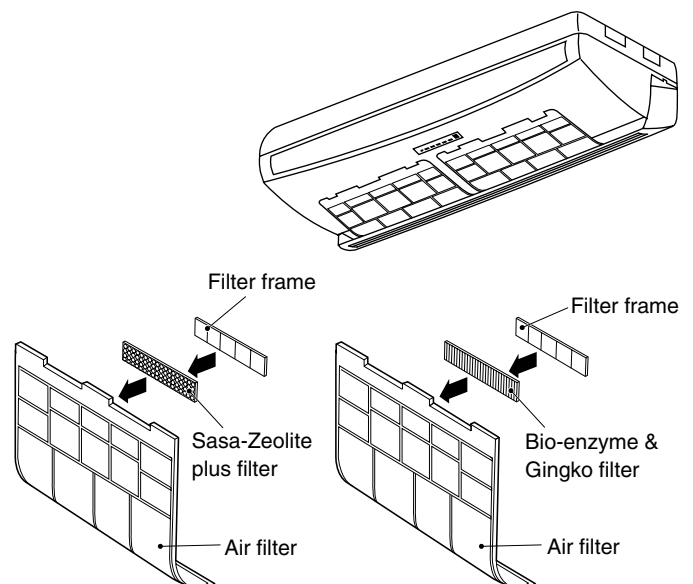

HANDLING THE REMOTE CONTROLLER

CAUTION

- The air conditioner will not operate if curtains, doors or other materials block the signals from the remote controller to the indoor unit.
- Prevent any liquid from falling into the remote controller.
- Do not expose the remote controller to direct sunlight or heat.
If the infrared signal receiver on the indoor unit is exposed to direct sunlight, the air conditioner may not function properly.
Use curtains to prevent the sunlight from reaching the receiver.
- If the room using the air conditioner has fluorescent lighting with electronic starters, signals may not be properly received. If you are planning to use such fluorescent lamps, consult your local dealer.
- If other electrical appliances react to the remote controller, move these appliances or consult your local dealer.

Location of the remote controller

- Keep the remote controller where its signals can reach the receiver of the indoor unit (a distance of 7 m is allowed).
- When you select the timer operation, the remote controller automatically transmits a signal to the indoor unit at the specified time.
If you keep the remote controller in a position that hinders proper signal transmission, a time lag of up to 15 minutes may occur.

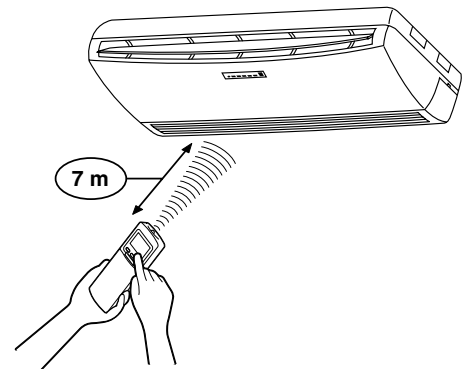

Remote controller holder

Installing the remote controller holder

- Before you actually install the remote controller holder on a wall or pillar, check whether the remote controller signals can be received by the indoor unit.

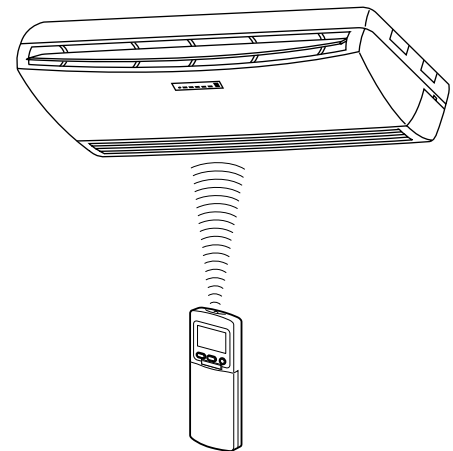

Mounting and removing the remote controller

- To mount the remote controller, hold it parallel to the remote controller holder and push it in fully. To remove the remote controller, slide the remote controller upwards and out from the holder.

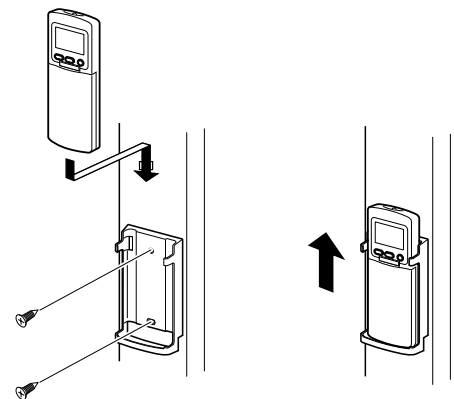

AUTOMATIC OPERATION

When you set the air conditioner in AUTO mode, it will automatically select cooling, heating, or fan only operation depending on the room temperature. (to see page 15.)

In addition, fan speed and louver are automatically controlled.

Start

(1) START/STOP button

Push this button to start the air conditioner.

(2) AUTO button (AUTO)

Push AUTO button.

- The OPERATION lamp (green) on the display panel of the indoor unit lights. The operating mode is selected in accordance with the room temperature and operation starts after approximately 3 minutes.
- If the AUTO mode is uncomfortable, you can select the desired conditions manually.

Temperature, fan speed and louver position can be changed.

When fan speed or louver position is changed, MODE is also changed from AUTO to A.

At the same time, fan speed and louver positioning indications are indicated.

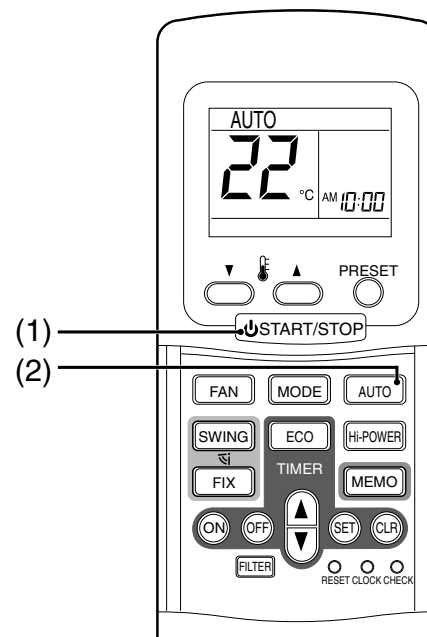

Stop

START/STOP button

Push this button again to stop the air conditioner.

AUTOMATIC OPERATION (AUTO CHANGEOVER)

When you set the air conditioner in A mode or switch over from AUTO operation because of some settings change, it will automatically select cooling, heating, or fan only operation depending on the room temperature. (to see page 15.)

Start

(1) START/STOP button

Push this button to start the air conditioner.

(2) Mode select button (MODE)

Select A.

(3) Temperature button (▼ ⬆ ▲)

Set the desired temperature.

- The OPERATION lamp (green) on the display panel of the indoor unit lights. The operating mode is selected in accordance with the room temperature and operation starts after approximately 3 minutes.
- When you select the A mode, it is unnecessary to set the fan speed. The FAN speed display will show AUTO and the fan speed will be automatically controlled.
- If the A mode is uncomfortable, you can select the desired conditions manually.

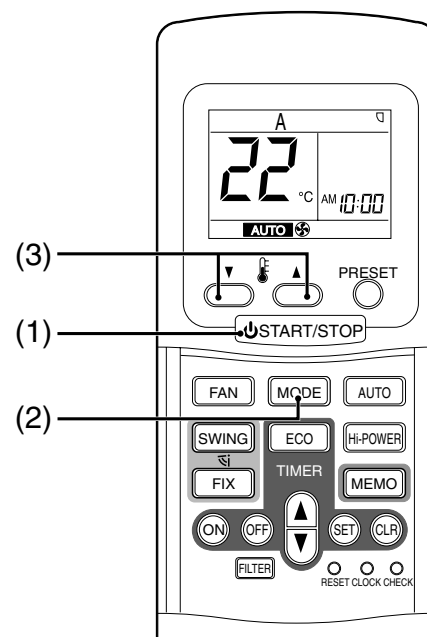

Stop

START/STOP button

Push this button again to stop the air conditioner.

COOLING/HEATING/FAN ONLY OPERATION

Start

(1) START/STOP button

Push this button to start the air conditioner.

(2) Mode select button (MODE)

Select Cool ☀, Heat ☁, or Fan only 🌀.

(3) Temperature button (▼ 🌡 ▲)

Set the desired temperature.

Cooling 21°C or higher.

Heating 28°C or lower.

When the air conditioner is in FAN ONLY operation, the temperature display is not indicated.

(4) Fan speed button (FAN)

Select one of "AUTO" LOW ▬, LOW+ ▬▬, MED ▬▬▬, MED+ ▬▬▬▬, HIGH ▬▬▬▬▬.

- The OPERATION lamp (green) on the display panel of the indoor unit goes on. And operation starts after approximately 3 minutes. (if you select FAN ONLY mode, the unit will start immediately.)
- The 🌀 : Fan only mode does not control temperature. Therefore, perform only steps (1), (2) and (4) to select this mode.

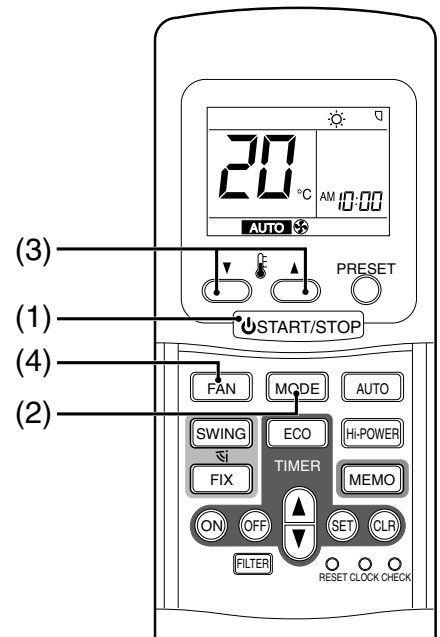

Stop

START/STOP button

Push this button again to stop the air conditioner.

DRY OPERATION

Start

(1) START/STOP button

Push this button to start the air conditioner.

(2) Mode select button (MODE)

Select DRY ☹.

(3) Temperature button (▼ 🌡 ▲)

Set the desired temperature.

- The fan speed display indicates AUTO.
- The OPERATION lamp (green) on the display panel of the indoor unit lights, and operation starts after approximately 3 minutes.

Stop

START/STOP button

Push this button again to stop the air conditioner.

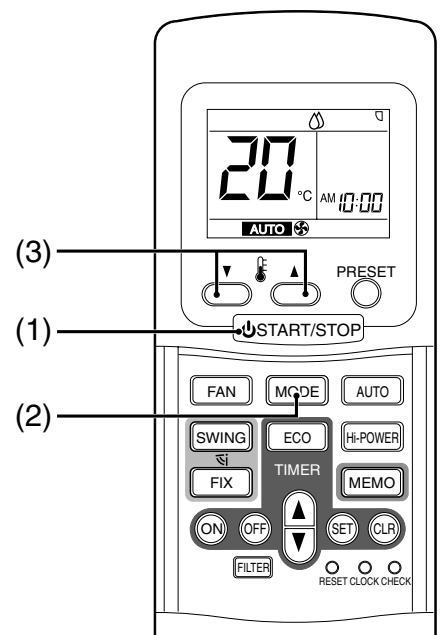

HIGH POWER OPERATION

High power (High POWER)

- The High POWER (high power operation) mode automatically controls room temperature, air flow and operation mode so that the room is quickly cooled in summer and warmed in winter.

Setting High POWER mode

(1) High POWER button

Push the High POWER button. The High POWER lamp (green) on the display panel of the indoor unit lights up. At the same time, the “High POWER” mark on the remote controller is indicated.

Canceling High POWER mode

(1) High POWER button

Push the High POWER button once again. The High POWER lamp on the display panel of the indoor unit lights goes out. At the same time, the “High POWER” mark on the remote controller goes out.

CAUTION

The High POWER mode cannot be activated in the DRY and FAN ONLY operation and when the ON TIMER operation is reserved.

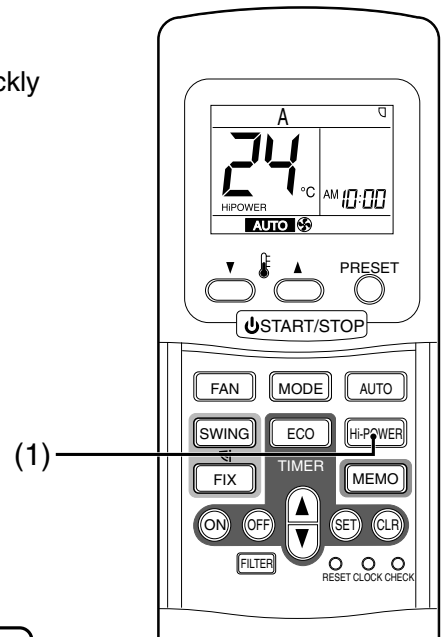

TIMER OPERATION

ON timer and OFF timer

Setting TIMER

(1) ON/OFF TIMER button

Push the ON or OFF TIMER buttons as required.

- The previous timer setting is displayed and flashes along with ON/OFF TIMER display.

(2) TIMER button

Push the TIMER button. Set the timer to the desired time. Each push of the TIMER button changes the time in ten minute steps. Pushing the TIMER button continually changes the time in one hour steps.

(3) SET button

Push the SET button to set the timer. The timer time is indicated and the timer starts.

(4) CLR button

Push the CLR button to cancel the timer setting.

CAUTION

- When you select the timer operation, the remote controller automatically transmits the timer signal to the indoor unit at the specified time. Therefore, keep the remote controller in a location where it can transmit the signal to the indoor unit properly.
- If you do not push the SET button within 30 seconds after setting the time, the setting will be cancelled.

Once you select the timer operation mode, the settings are saved in the remote controller.

Thereafter, the air conditioner will start operating under the same conditions when you simply push the ON/OFF button of the remote controller.

If the clock display is flashing, you cannot set the timer.

Follow the instructions in the section “SETTING THE CLOCK” on page 6 to set the clock, and then set the timer.

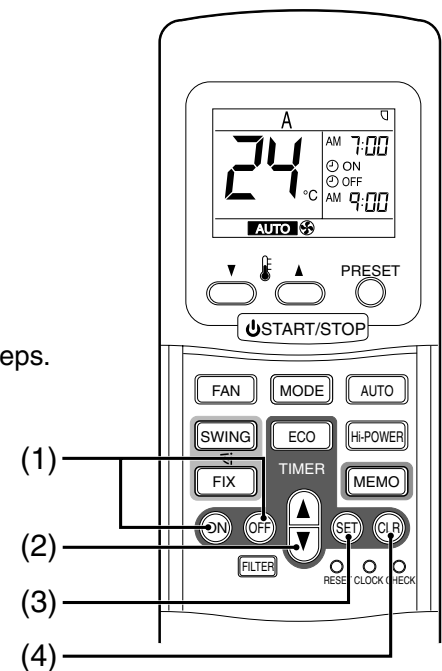

Combined timer (Setting both ON and OFF timers simultaneously)

OFF timer → ON timer

(Operation → Stop → Operation)

This feature is useful when you want to stop the air conditioner after you go to sleep, and start it again in the morning when you wake up or you return home.

Example:

To stop the air conditioner and start it again next morning.

Setting combined TIMER

- (1) Push the OFF (OFF) button.
- (2) Push the TIMER (A) button to adjust the OFF timer.
- (3) Push the ON (ON) button.
- (4) Push the TIMER (A) button to adjust the ON timer.
- (5) Push the SET (SET) button.

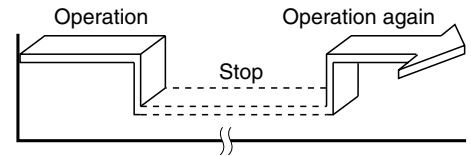

ON timer → OFF timer

(Stop → Operation → Stop)

You can use this setting to start the air conditioner when you wake up and stop it when you leave the house.

Example:

To start the air conditioner next morning and stop it.

Setting combined TIMER

- (1) Push the ON (ON) button.
- (2) Push the TIMER (A) button to adjust the ON timer.
- (3) Push the OFF (OFF) button.
- (4) Push the TIMER (A) button to adjust the OFF timer.
- (5) Push the SET (SET) button.

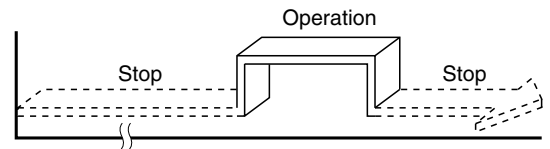

- Either ON or OFF timer function which is closer to the current time, is activated first.
- If the same time is set for both ON and OFF timers, no timer operation is performed. Also, the air conditioner may stop operating.

Every day combined timer (setting both ON and OFF timer simultaneously and activate every day.)

This feature is useful when you want to use combined timer at the same time every day.

Setting combined TIMER

- (1) Push the ON (ON) button.
- (2) Push the TIMER (A) button to adjust the ON timer.
- (3) Push the OFF (OFF) button.
- (4) Push the TIMER (A) button to adjust the OFF timer.
- (5) Push the SET (SET) button.
- (6) After step (5), an arrow mark (↑ or ↓) flashes for about 3 seconds and during this flashing, push the SET (SET) button.

- During the every day timer is activating, both arrows (↑, ↓) are indicated.

Cancel the timer operation

Push the CLR (CLR) button.

Clock display

During the TIMER operation (ON-OFF, OFF-ON, OFF timer) clock display is disappeared so as to show the setting time. To see the present time, push SET button briefly and the present time is displayed about 3 seconds.

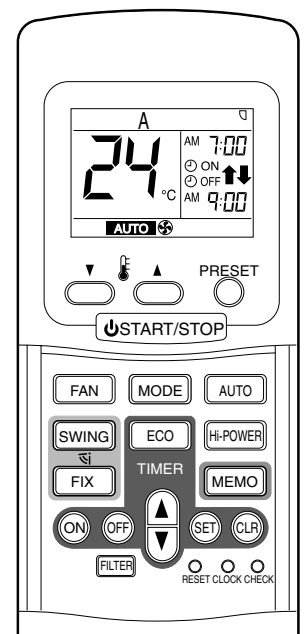

MEMORY/PRESET OPERATION

Memorize the frequently used operation setting by the MEMO button for convenience.

Start the air conditioner in the operation mode which you want the remote controller to memorize.

Push the button as follows while the air conditioner is in operation.

(1) MEMO button

Push this button briefly to standby memorizing the setting.

All the icons currently displayed except for the clock display and **P** mark flashes.

(2) MEMO button

Push and hold the MEMO button for more than 3 seconds while the display flashes.

The **P** mark is indicated and the setting is memorized.

- If you do not push the MEMO button within 3 seconds or if you push another button, the MEMORY setting is cancelled.
- Operation modes which can be memorized with the MEMO button are MODE, Temperature, FAN, TIMER and High POWER.

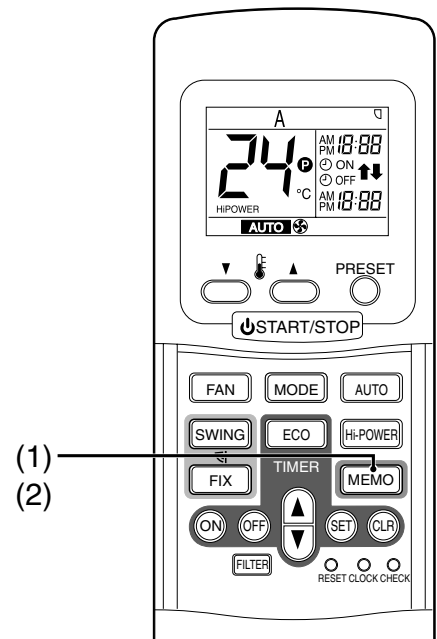

To operate the air conditioner with the setting memorized by the MEMO button.

(1) PRESET button

Push the PRESET button. The setting memorized with the MEMO button will be indicated and the air conditioner operates with regards to the setting.

- The OPERATION lamp (green) on the display panel of the indoor unit goes on, and operation starts after approximately 3 minutes.

- Initial setting:

MODE : AUTO

Temperature : 22

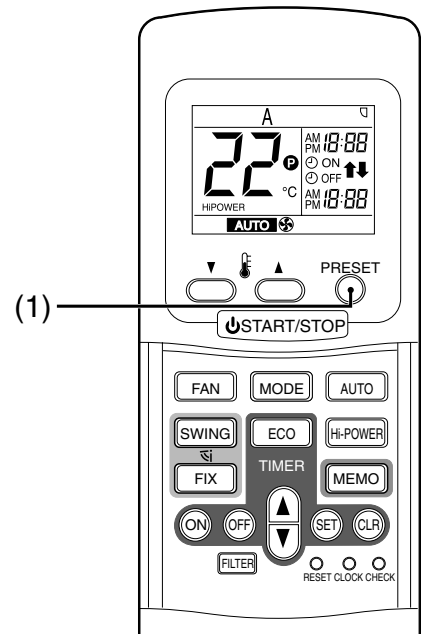

ADJUSTING AIR FLOW DIRECTION

- Adjust the air flow direction properly. Otherwise, it might cause discomfort and make the room temperature uneven.
- Adjust the vertical air flow using the remote controller.
- Adjust the horizontal air flow manually.

Adjust the vertical air flow

The air conditioner automatically adjusts the vertical air flow direction in accordance with the operating conditions when AUTO or A mode is selected.

To set the air flow direction you desire

Perform this function when the air conditioner is in operation.

(1) FIX button

Keep pushing or pushing briefly the FIX button on the remote controller to move the louver in the desired direction.

- Change the vertical air flow louver direction within the range indicated.
- In subsequent operations, the vertical air flow is automatically set in the direction to which you adjusted the louver using the FIX button.

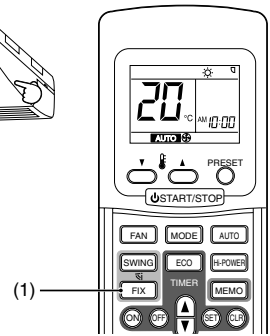
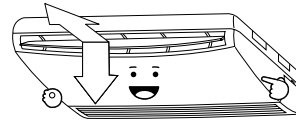

To automatically swing the air flow direction

Perform this function when the air conditioner is in operation.

(1) SWING button

Push the SWING button on the remote controller.

- To stop the function, push the SWING button.
- To change the swing direction, push the FIX button.

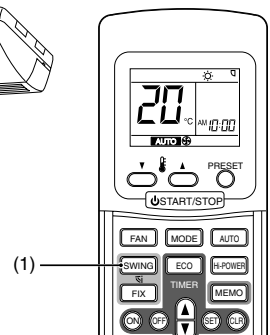
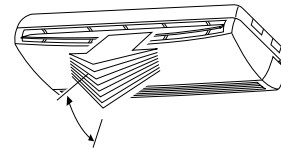

CAUTION

- The FIX and SWING buttons will be disabled when the air conditioner is not in operation (including when the ON TIMER is set).
- Do not operate the air conditioner for long hours with the air flow direction set downward during the cooling or dry operation. Otherwise, condensation may occur on the surface of the vertical air flow louver and cause dew dripping.
- Do not move the vertical air flow louver manually. Always use the FIX button.
If you move the louver manually, it may malfunction during operation. If the louver malfunctions, stop the air conditioner once, and restart.
- When the air conditioner is started immediately after it was stopped, the vertical air flow louver might not move for 10 seconds or so.

Adjust the horizontal air flow

Preparation:

- Take hold of the lever on the horizontal air flow louver and move them to adjust the air flow direction as required.
- You can adjust the air flow at the left, center, and right locations of the grilles.

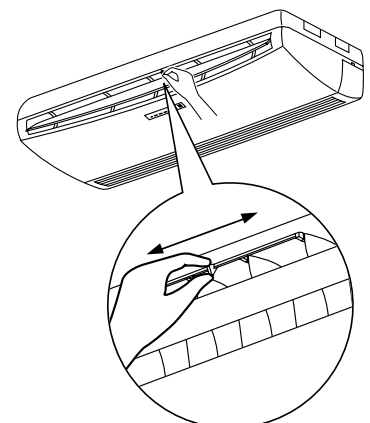
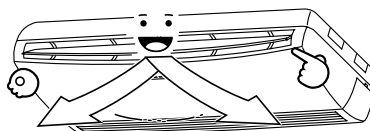

AUTO RESTART OPERATION

This air conditioner is equipped with an Automatic restarting facility which allows the air conditioner to resume the set operating conditions in the event of a supply power shutdown without the use of the remote controller. The operation will resume without warning three minutes after the power is restored.

INFORMATION

The AUTO RESTART OPERATION is not set to work on shipment from the factory, and so it is necessary to set it to function as required.

HOW TO SET THE AUTO RESTART

To set the auto restart function, proceed as follows:

The power supply to the unit must be on the function will not set if the power is off.

To enable the auto restart function, push the TEMPORARY button continually for 3 seconds.

The air conditioner will acknowledge the setting and beep 3 times. The system will now restart automatically.

The above auto restart settings can be carried out:

(1) When the air conditioner is in stand-by (not running).

Push the TEMPORARY button for more than 3 seconds.

- The air conditioner starts to operate.
The green lamp will be indicated.
- About 3 seconds after, the air conditioner beeps 3 times.
The lamp will change from green to orange.
- The air conditioner is operating.

If the air conditioner is not required to run at this time, push the TEMPORARY button once more or use the remote controller to stop the air conditioner.

(2) When the air conditioner is in operation.

Push the TEMPORARY button for more than 3 seconds.

- The air conditioner stops operating.
The green lamp goes off.
- The air conditioner beeps 3 times 3 seconds later, after pushing the button.
- The air conditioner stops.

If the air conditioner is not required to stop at this time, use the remote controller to restart the air conditioner. During the subsequent operation, the orange lamp is indicated.

- The auto restart operation will not accept an instruction if timer operation with the remote controller is selected.
- The louver swing operation will not resume, after restarting the air conditioner by the AUTO RESTART OPERATION.

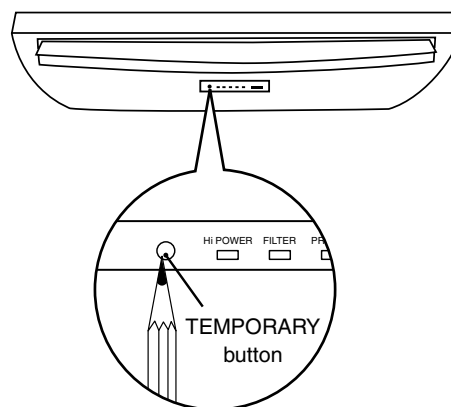

HOW TO CANCEL THE AUTO RESTART

To cancel the auto restart operation, proceed as follows:

Repeat the setting procedure: the air conditioner will acknowledge the instruction and beep three times.

The air conditioner will now require to be manually restarted with the remote controller after the main supply is turned off.

Cancellation is carried out:

(1) When the air conditioner is in stand-by (not running).

Push the TEMPORARY button for more than 3 seconds.

- The air conditioner starts to operate.
The orange lamp will be indicated.
- About 3 seconds after, the air conditioner beeps 3 times.
The lamp will change from orange to green.
- The air conditioner is operating.

If the air conditioner is not required to run at this time, push the TEMPORARY button once more or use remote controller to stop the air conditioner.

(2) When the air conditioner is in operation.

Push the TEMPORARY button for more than 3 seconds.

- The air conditioner stops operating.
The orange lamp is turned off.
- About 3 seconds after, the air conditioner beeps 3 times.
- The air conditioner stops.

If the air conditioner is not required to stop at this time, use the remote controller to restart the air conditioner. During subsequent operation, the green lamp is indicated.

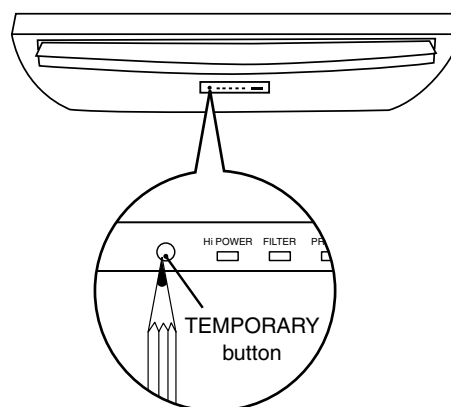

HOW THE AIR CONDITIONER WORKS

Automatic operation

- The air conditioner selects and operates in one of the operating modes of cooling, heating, or fan only, depending on the room temperature.
- If the AUTO mode is uncomfortable, you can select the desired conditions manually.

Room temperature in operation	Operating condition	
The set temperature +1°C or higher (in case that the room is hot)	Cooling operation	Performs the cooling operation at a temperature 1°C higher than the setting.
The set temperature -1°C to +1°C	Fan only operation	Performs the fan only operation (low speed) while monitoring the room temperature. When the room temperature changes, the air conditioner will select the cooling or heating mode.
The set temperature -1°C or lower (in case that the room is cold)	Heating operation	Performs the heating operation at a temperature 1°C lower than the setting.

ECO timer operation

When you push the ECO button during cooling, heating or A operation, the air conditioner will start the following operation.

The fan speed will be automatically controlled.

After setting hours (1, 3, 5 or 9 hours) operation, the air conditioner will stop.

• Cooling operation (⚙️)

In the operation suppression zone, where capacity is kept to the minimum, overcooling is prevented by raising the temperature setting by 1°C after 1 hour and by 2°C after 2 hours of operation. The room temperature is thus regulated between the operation suppression zone and the set temperature.

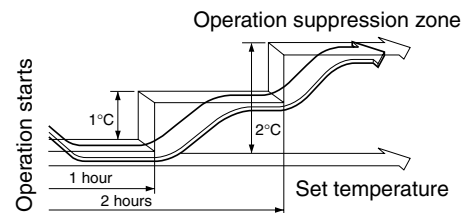

• Heating operation (☀️)

In the operation suppression zone, where capacity is kept to the minimum, overheating is prevented by lowering the temperature setting by 1°C after 1 hour and by 2°C after 2 hours of operation. The room temperature is thus regulated between the set temperature and the operation suppression zone.

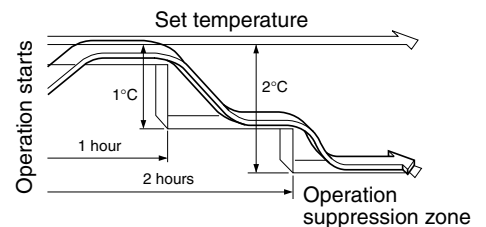

HINTS FOR ECONOMICAL OPERATION

Maintain room temperature at comfortable level

Clean air filters

The clogged air filters impairs the performance of the air conditioner. Clean them every 2 weeks.

Never open doors and windows more often than necessary

To keep cool or warm air in the room, never open doors and windows more often than necessary.

Window curtains

In cooling, close the curtains to avoid direct sunlight. In heating, close the curtains to keep the heat in.

Use the timer effectively

Set the timer for the desired operating time.

Get uniform circulation of room air

Adjust air flow direction for even circulation of room air.

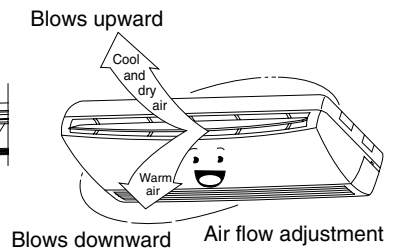
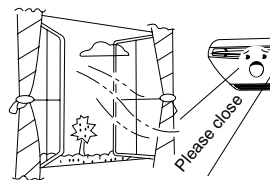
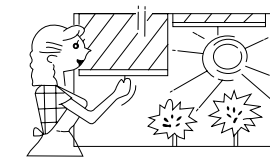
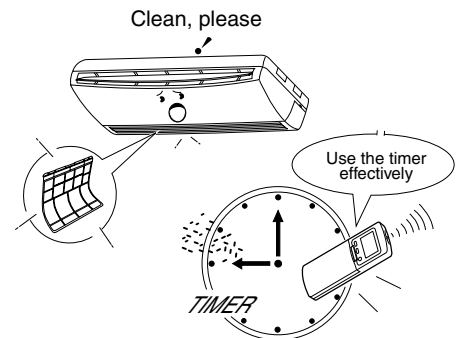
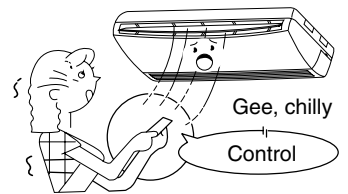

TEMPORARY OPERATION

TEMPORARY operation

This function is used to operate the unit temporarily in case you misplace the remote controller or its batteries are exhausted.

- Push the TEMPORARY button to start the air conditioner.
- While the substitute operation is set, the remote controller operation is disabled.
- Continue to push the button for 10 seconds to start the cooling operation.

Air filter reset

When the FILTER lamp on the air conditioner is indicated, it is time for cleaning. (The lamp will start to indicate, after every 1000 hours of operation.)

- The FILTER lamp will go out when the TEMPORARY button is pushed.
- The FILTER lamp will also go out when the FILTER button on the remote controller is pushed. (to see page 4.)

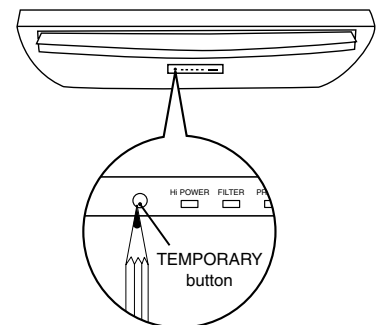
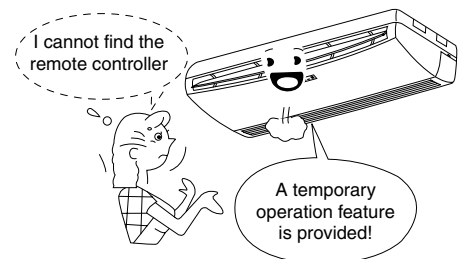

MAINTENANCE

WARNING

Before you clean the air conditioner, be sure to turn off the circuit breaker, or main power switch.

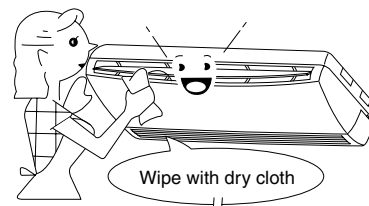

Cleaning of indoor unit and remote controller

CAUTION

- Use a dry cloth to wipe the indoor unit and remote controller.
- A cloth dampened with cold water may be used on the indoor unit if it is very dirty.
- Never use a damp cloth on the remote controller.
- Do not use a chemically-treated duster for wiping or leave such materials on the unit for long. It may damage or fade the surface of the unit.
- Do not use benzene, thinner, polishing powder, or similar solvents for cleaning. These may cause the plastic surface to crack or deform.
- Do not wash the unit with water. It may cause an electric shock.
- Do not use alcohol, benzene, thinner, glass cleaner, polishing powder, etc. for cleaning the unit, because they deteriorate in electric insulation.

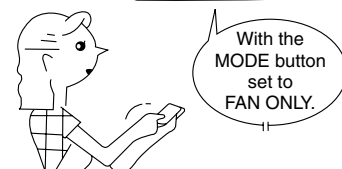

FAN ONLY operation

If you will not use the unit for at least 1 month

- (1) Operate the air conditioner in FAN ONLY mode for about half a day to dry the inside of the unit.
- (2) Stop the air conditioner and turn off the circuit breaker.
- (3) Remove the batteries from the remote controller.

Check before operation

CAUTION

- Check that the Air filters are installed.
- Check that the Air outlet or inlet of the outdoor unit is not blocked.

Cleaning the Air filter

Clean the Air filters every 2 weeks.

If the Air filters are covered with dust, the performance of the air conditioner will deteriorate.

Clean the Air filters as often as possible.

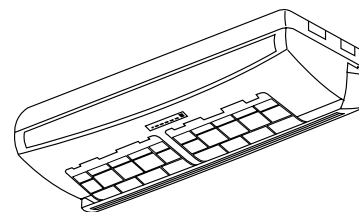

(1) Open the Air inlet grille with both hands until the stop position.

(2) Remove the Air filters from Front panel.

(3) Remove the Sasa-Zeolite plus filter and Bio-enzyme & Gingko filter from the Air filters.

(4) Use a vacuum cleaner to remove the dust from the filters or wash them with water. If you wash the Air filters, dry them in the shade.

(5) Install the Sasa-Zeolite plus filter and Bio-enzyme & Gingko filter in Filter frame.

(6) Insert the Air filters into the front panel guide, and hook it into position.

(7) Close the Air inlet grille.

If the FILTER lamp on the indoor unit is indicated, push the FILTER button on the remote controller, or the TEMPORARY button on the indoor unit to turn off the lamp.

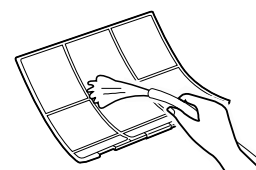
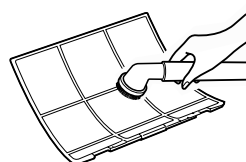
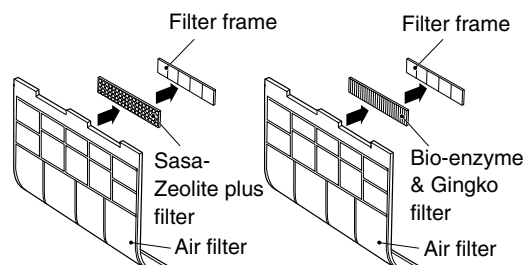

INFORMATION

Sasa-Zeolite plus filter

Maintaining your strong deodorizing and anti-virus filter.

Clean every 6 months or when dust covers the filter.

1. Gently clean the surface of the filter with a vacuum cleaner.
2. If the filter remains unclean, rinse it briefly and gently in cool water.
3. Dry under the sunlight at least 6 hours to recharge Zeolite's deodorizing properties.
4. Replace every 2 years. (P/N : RB-A610DE)

Bio-enzyme & Gingko filter

Maintaining your strong purifying and anti-allergy filter.

Clean every 6 months or when dust covers the filter.

1. Gently clean the surface of the filter with a vacuum cleaner.
(Do not use water to clean the filter.)
2. Replace every 2 years. (P/N : RB-A606SE)

Note: Filter life depends on the level of impurities in your operating environment. Higher levels of impurities may require more frequent cleaning and replacement. In all cases, Toshiba recommends an additional set of filters to improve the purifying and deodorizing performance of your air conditioner.

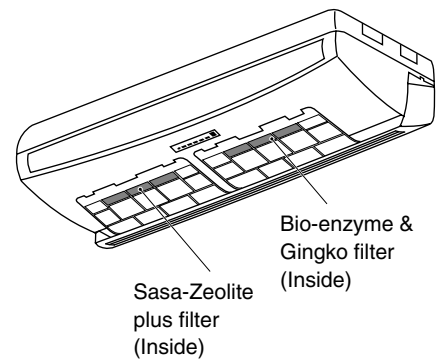

AIR CONDITIONER OPERATIONS AND PERFORMANCE

Three-minute protection feature

A protection feature prevents the air conditioner from being activated for approximately 3 minutes when it is restarted immediately after operation or when the power supply switch is set to on. This will protect the machine.

Heating characteristics

Preheating operation

The air conditioner will not deliver warm air immediately after it is started.

Warm air flows out after approximately 5 minutes when the indoor heat exchanger warms up. (The PRE.DEF lamp is on during this intervals indicating the preheating operation.)

Warm air control

When the room temperature reaches the set temperature, the fan indoor speed is automatically reduced to prevent a cold draft.

At this time, the outdoor unit will stop.

Defrosting

If the outdoor unit is frosted during heating operation, defrosting is started automatically (for approximately 5 to 10 minutes) to maintain the heating effect, and the PRE.DEF lamp is on.

- The fans in both the indoor and outdoor units stop during the defrost operation.
- During defrost operation, defrosted water is drained from the bottom plate of the outdoor unit.

Heating capacity

In the heating operation, heat is absorbed from outdoors and released into the room. That is called the heat pump system. When the outdoor temperature is too low, to use another heating apparatus in combination with the air conditioner is recommended.

Consideration for accumulated snow

Select the position for the outdoor unit where it will not be subjected to snow drifts, accumulation of leaves or other seasonal debris. It is important that the air flow of the outdoor unit is not impeded as this will result in reduced heating or cooling performance. During the heating mode, and at sub-zero temperatures, the water drained off the outdoor unit as a result of the automatic defrost may accumulate and freeze. It is important that adequate drainage or a soak-way is provided.

Power failure

Power failure during operation will stop the unit completely.

- The OPERATION lamp (green) on the indoor unit will start flashing when power is restored.
- To restart operation, push the START/STOP button on the remote controller.
- Lightning or a car wireless telephone operating nearby may cause the unit to malfunction. Turn the power supply switch to off and then to on. Push the START/STOP button on the remote controller to restart.

Air conditioner operating conditions

For proper performance, operate the air conditioner under the following temperature conditions:

Cooling operation	Outdoor temperature : -15°C to 43°C
	Room temperature : 21°C to 32°C (Dry valve temp.), 15°C to 24°C (Wet valve temp.)
	CAUTION Room relative humidity – less than 80%. If the air conditioner operates in excess of this figure, the surface of the air conditioner may cause dewing.
Heating operation	Outdoor temperature : -15°C to 15°C (Wet valve temp.)
	Room temperature : -15°C to 28°C (Dry valve temp.)

If air conditioner is used outside of the above conditions, safety protection may work.

TROUBLES AND CAUSES

CAUTION

If any of the following conditions occur, stop the air conditioner immediately, set to off the main power switch and contact the dealer:

- The indicator lamps blink at short intervals (5 Hz). Reset the circuit breaker 2 to 3 minutes after the power main switch is turned off. Despite the above-mentioned resetting the lamps still continue going on and off.
- Switch operation are erratic.
- The main power fuse often blows out, or the circuit breaker is often activated.
- Foreign matter or water has fallen inside the air conditioner.
- Any other unusual condition is observed.

Before you ask for servicing or repairs, check the following points.

Inoperative

- The power main switch is turned off.
- The circuit breaker is activated to cut off the power supply.
- The main power fuse has blown out.
- Stoppage of electric current.
- The batteries in the remote controller are exhausted.
- ON timer is set.



Poor cooling or heating performance

- The air inlet or outlet of the outdoor unit is blocked.
- Doors or windows are opened.
- The air filter is clogged with dust.
- The louver is not at the correct position.
- The fan speed is set to low.
- The air conditioner is set in the DRY mode.
- The set temperature is too high. (In cooling operation)
- The set temperature is too low. (In heating operation)

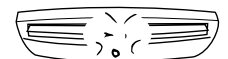

Recheck

Before you ask for servicing or repairs, check the following points.

The back of indoor unit is dewed.

- Dewdrops on the back of the indoor unit are automatically collected and drained out.

Indoor unit or outdoor unit makes a strange noise.

- When temperature sharply changes, the indoor or outdoor unit occasionally makes a strange noise (like tit-tack noise or flowing noise) because of expansion/contraction of parts or change of refrigerant flow.

The room air is smelly.

A bad odor comes from the air conditioner.

- Smells impregnated in the wall, carpet, furniture, clothing, or furs, are coming out.

The OPERATION lamp goes on and off.

- The lamp goes on and off 1 Hz when power is restored after a power failure, or when the power main switch is set to on. Reset the circuit breaker to ON.

Outdoor unit is frosted in heating operation.

Water is drained out of outdoor unit.

- The outdoor unit is sometimes frosted in heating operation. In that case, the unit automatically performs defrosting (for 2 to 10 minutes) for raising the heating efficiency.
- In defrosting operation, both the indoor and outdoor units stop air flow.
- Hiss sound is heard when flow of the refrigerant is changed for defrosting.
- Resultant water of automatic defrosting in heating operation is drained out of the outdoor unit.

Air flow changes though the FAN button is not set to the AUTO mode.

- When the temperature of blown air goes down in heating operation, the air conditioner automatically changes or stops air flow from the indoor unit not to make persons in the room feel chilly.

A white mist of chilled air or water is generated from the outdoor unit.

- The indoor unit in cooling operation or the outdoor unit in defrosting operation occasionally steams.

Automatic operation of vertical air flow louver.

- When the room temperature or outdoor temperature is high in the heating operation, the vertical air flow louver once close and then set themselves automatically to the original set position again.

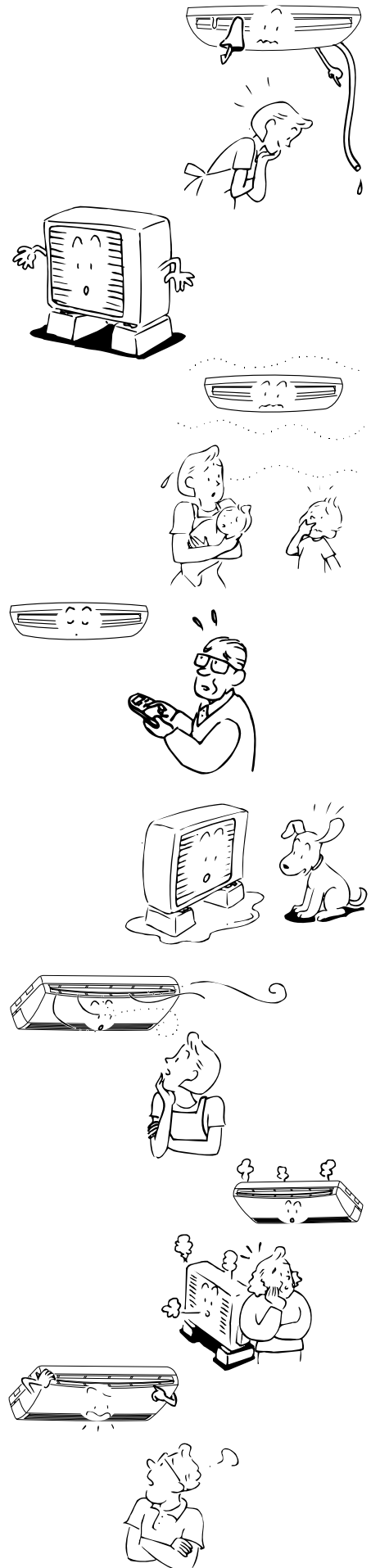

These are not failures.

SPECIFICATIONS

Type			Reverse cycle, Under Ceiling/Console Type			
Model			Indoor Unit		Outdoor Unit	
			RAV-SM562XT-E		RAV-SM562AT-E	
Power supply			50Hz, 220-240 V~		50Hz, 220-240 V~	
Cooling capacity	(kW)	CAPA.	5.0 (1.5 ~ 5.6)		6.7 (1.5 ~ 8.0)	
Heating capacity	(kW)	CAPA.	5.6 (1.5 ~ 6.3)		8.0 (1.5 ~ 9.0)	
Cooling Amps	(A)	AMP.	0.52	8.43 – 7.68	0.52	12.63 – 11.54
Cooling Watts	(W)	WATT.	110	1760	110	2610
Heating Amps	(A)	AMP.	0.52	7.61 – 6.94	0.52	12.39 – 11.32
Heating Watts	(W)	WATT.	110	1590	110	2560
Dimension	Width	(mm)	1093	780	1093	900
	Height	(mm)	633	550	633	780
	Depth	(mm)	208	290	208	550
Net weight		(kg)	23	38	23	42

- The specifications may be subject to change without notice for purpose of improvement.
The specified air-conditioning capabilities are based on the data determined under the following conditions:

For cooling

Air-inlet temperature °C			
Indoor coil assembly		Outdoor coil assembly	
Dry bulb	Wet bulb	Dry bulb	Wet bulb
27	19	35	24

For heating

Air-inlet temperature °C			
Indoor coil assembly		Outdoor coil assembly	
Dry bulb	Wet bulb	Dry bulb	Wet bulb
20	—	7	6

TROUBLES AND CAUSES (Concerning Remote Controller)

Before you ask for servicing or repairs, check the following points.

Setting Change Is Impossible		
Symptoms	Causes	Reason and Disposal
The fan speed cannot be changed.	<ul style="list-style-type: none"> Check whether the MODE indicated on the display is "AUTO". <p style="text-align: center;">AUTO</p>	When the automatic mode is selected, the air conditioner automatically selects the fan speed.
	<ul style="list-style-type: none"> Check whether the MODE indicated on the display is "☹ : DRY". <p style="text-align: center;">☹ : DRY</p>	When dry operation is selected, the air conditioner automatically selects the fan speed. The fan speed can be selected during "⚙ COOL", "☀ HEAT" and "🌀 FAN ONLY".

The Display Never Goes On		
Symptoms	Causes	Reason
The temperature display does not go on.	<ul style="list-style-type: none"> Check whether the MODE indicated on the display is "🌀 : FAN ONLY". <p style="text-align: center;">🌀 : FAN ONLY</p>	The temperature cannot be set during fan only operation.

The Display Goes Off		
Symptoms	Causes	Reason
The indication on the display disappears after a lapse of time.	<ul style="list-style-type: none"> Check whether the timer operation has come to an end when the OFF TIMER is indicated on the display. 	The air conditioner stops since the setting time elapsed.
The TIMER display goes off after a certain period of time.	<ul style="list-style-type: none"> Check whether the timer operation has started when the ON TIMER is indicated on the display. <p style="text-align: center;">🕒 : ON</p>	When the time reaches the setting time for the ON timer operation, the air conditioner starts to operate automatically and the ON timer display goes off.

The Signal Receiving Tone Does Not Sound		
Symptoms	Causes	Reason
No receiving tone sounds from the indoor unit even when the START/STOP button is pushed.	<ul style="list-style-type: none"> Check whether the signal transmitter of the remote controller is properly directed to the receiver of the indoor unit when the START/STOP button is pushed. 	Direct the signal transmitter of the remote controller to the receiver of the indoor unit, and then repeatedly push the START/STOP button.

MEMO
