

# TOSHIBA

**OUTDOOR UNIT INSTALLATION MANUAL**  
MANUEL D'INSTALLATION DE L'UNITE EXTERIEURE  
INSTALLATIONSHANDBUCH AUSSENEINHEIT  
MANUALE D'INSTALLAZIONE DELL'UNITÀ ESTERNA  
MANUAL DE INSTALACIÓN DE LA UNIDAD EXTERIOR  
MANUAL DE INSTALAÇÃO DA UNIDADE EXTERIOR  
INSTALLATIEHANDLEIDING VOOR DE BUITENUNIT  
ΕΓΧΕΙΡΙΔΙΟ ΕΓΚΑΤΑΣΤΑΣΗΣ ΕΞΩΤΕΡΙΚΗΣ ΜΟΝΑΔΑΣ

**AIR CONDITIONER (SPLIT TYPE)**  
**CLIMATISEUR (TYPE SPLIT)**  
**KLIMAGERÄT (SPLIT-TYP)**  
**CONDIZIONATORE D'ARIA (TIPO SPLIT)**  
**AIRE ACONDICIONADO (TIPO SPLIT)**  
**AR CONDICIONADO (TIPO SPLIT)**  
**AIRCONDITIONER (GESPLITST TYPE)**  
**ΚΛΙΜΑΤΙΣΤΙΚΟ (ΤΥΠΟΣ SPLIT)**

Heat Pump Model  
Modèle à thermopompe  
Geräte mit Heizung  
Modello con pompa di riscaldamento  
Modelo con bomba de calor  
Modelo de bomba térmica  
Model met warmtepomp  
Μοντέλο με Αντλία Θερμότητας



**RAV-SP1102AT-E**  
**RAV-SP1402AT-E**

Please read this Installation Manual carefully before installing the Air Conditioner.

- This Manual describes the installation method of the outdoor unit.
- For installation of the indoor unit, follow the Installation Manual attached to the indoor unit.

Veuillez lire attentivement ce Manuel d'installation avant d'installer le climatiseur.

- Ce manuel décrit la procédure d'installation de l'unité extérieure.
- Pour installer l'unité intérieure, reportez-vous au Manuel d'installation fourni avec l'unité intérieure.

Bitte lesen Sie dieses Handbuch sorgfältig, bevor Sie mit der Installation des Klimagerätes beginnen.

- In diesem Handbuch wird die Installation der Außeneinheit beschrieben.
- Um die Raumeinheit zu installieren, folgen Sie den Anweisungen in dem Handbuch, das der Raumeinheit beiliegt.

Prima di installare il condizionatore d'aria, leggere con attenzione questo manuale d'installazione.

- Questo manuale descrive il metodo d'installazione dell'unità esterna.
- Per l'installazione dell'unità interna, fare riferimento al manuale d'installazione fornito insieme all'unità interna.

Lea atentamente este Manual de instalación antes de proceder a la instalación del aparato de aire acondicionado.

- Este manual describe el método de instalación de la unidad exterior.
- Para la instalación de la unidad interior, consulte el Manual de instalación que acompaña a la unidad interior.

Leia atentamente o presente Manual de Instalação antes de instalar o Ar Condicionado.

- O presente manual descreve o método de instalar a unidade exterior.
- Para a instalação de uma unidade interior, siga o Manual de Instalação que acompanha a unidade interior.

Lees deze installatiehandleiding zorgvuldig door voordat u de airconditioner gaat installeren.

- Deze installatiemethode beschrijft de installatiemethode van de buitenunit.
- Zie voor de installatie van de binnenunit, de installatiehandleiding bij de binnenunit.

Παρακαλώ διαβάστε προσεκτικά το Εγχειρίδιο Εγκατάστασης πριν από την εγκατάσταση του Κλιματιστικού.

- Το παρόν Εγχειρίδιο περιγράφει τη μέθοδο εγκατάστασης της εξωτερική μονάδας.
- Για την εγκατάσταση της εσωτερικής μονάδας, ακολουθήστε το Εγχειρίδιο Εγκατάστασης που συνοδεύει την εσωτερική μονάδα.

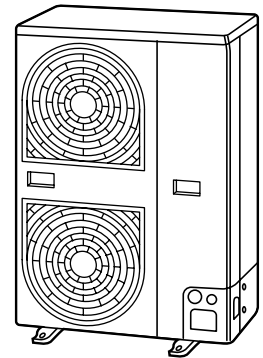

## **ADOPTION OF NEW REFRIGERANT**

This Air Conditioner is a new type which adopts a new refrigerant HFC (R410A) instead of the conventional refrigerant R22 in order to prevent destruction of the ozone layer.

---

## **UTILISATION DU NOUVEAU REFRIGERANT**

Ce climatiseur est d'un type inédit qui utilise le nouveau réfrigérant HFC (R410A) au lieu du réfrigérant traditionnel R22, afin d'éviter la destruction de la couche d'ozone.

---

## **EINFÜHRUNG EINES NEUEN KÜHLMITTELS**

Dies ist ein neuartiges Klimagerät. Anstatt des herkömmlichen Kühlmittels R22 verwendet es das neue ozonschichtschonende HFC Kühlmittel R410A.

---

## **ADOZIONE DI UN NUOVO REFRIGERANTE**

Questo condizionatore d'aria è di un tipo nuovo che adotta un nuovo refrigerante HFC (R410A) al posto del refrigerante convenzionale R22, per prevenire la distruzione dello strato di ozono dell'atmosfera terrestre.

---

## **ADOPCIÓN DE NUEVO REFRIGERANTE**

Este aparato de aire acondicionado es un modelo reciente que incorpora el nuevo refrigerante HFC (R410A) en lugar del refrigerante convencional R22 para así evitar daños en la capa de ozono.

---

## **ADOPÇÃO DO NOVO REFRIGERANTE**

Este ar condicionado é um modelo novo que adota um novo refrigerante HFC (R410A) em vez do refrigerante convencional R22 para evitar a destruição da cama de ozono.

---

## **TOEPASSING VAN EEN NIEUW KOELMIDDEL**

Deze airconditioner is een nieuwe type dat werkt met een nieuw koelmiddel HFC (R410A) in plaats van met het conventionele koelmiddel R22, als bijdrage om de aantasting van de ozonlaag te reduceren.

---

## **ΥΙΟΘΕΤΗΣΗ ΝΕΟΥ ΨΥΚΤΙΚΟΥ**

Το παρόν Κλιματιστικό είναι νέος τύπος που υιοθετεί νέο ψυκτικό HFC (R410A) στη θέση του συμβατικού ψυκτικού R22 προκειμένου να βοηθήσει στην προστασία του όζοντος.

## CONTENTS

<b>1</b>	PRECAUTIONS FOR SAFETY .....	1	<b>5</b>	EVACUATING .....	9
<b>2</b>	ACCESSORY AND REFRIGERANT .....	2	<b>6</b>	ELECTRICAL WORK .....	11
<b>3</b>	SELECTION OF INSTALLATION .....	3	<b>7</b>	FINAL INSTALLATION CHECKS .....	12
<b>4</b>	REFRIGERANT PIPING .....	7			

## SOMMAIRE

<b>1</b>	MESURES DE SECURITE .....	14	<b>5</b>	EVACUATION DE L'AIR .....	22
<b>2</b>	ACCESSOIRES ET REFRIGERANT .....	15	<b>6</b>	INSTALLATION ELECTRIQUE .....	24
<b>3</b>	CHOIX DE L'INSTALLATION .....	16	<b>7</b>	DERNIERES VERIFICATIONS DE L'INSTALLATION	25
<b>4</b>	TUYAUX DE REFRIGERANT .....	20			

## INHALT

<b>1</b>	SICHERHEITSVORKEHRUNGEN .....	27	<b>5</b>	ENTLÜFTEN DER ROHRLEITUNGEN .....	35
<b>2</b>	ZUBEHÖR UND KÜHLMITTEL .....	28	<b>6</b>	ELEKTROINSTALLATION .....	37
<b>3</b>	VORBEREITUNGEN FÜR DIE INSTALLATION .....	29	<b>7</b>	ÜBERPRÜFUNGEN NACH DER INSTALLATION .....	38
<b>4</b>	KÜHLMITTELLLEITUNGEN .....	33			

## INDICE

<b>1</b>	PRECAUZIONI PER LA SICUREZZA .....	40	<b>5</b>	SVUOTAMENTO .....	48
<b>2</b>	ACCESSORI E REFRIGERANTE .....	41	<b>6</b>	ESECUZIONE DEI COLLEGAMENTI ELETTRICI .....	50
<b>3</b>	SCELTA DEL POSTO D'INSTALLAZIONE .....	42	<b>7</b>	CONTROLLI DI FINE INSTALLAZIONE .....	51
<b>4</b>	TUBAZIONI DEL REFRIGERANTE .....	46			

## CONTENIDO

<b>1</b>	PRECAUCIONES PARA SU SEGURIDAD .....	53	<b>5</b>	EVACUACIÓN .....	61
<b>2</b>	ACCESORIOS Y REFRIGERANTE .....	54	<b>6</b>	TRABAJOS EN EL SISTEMA ELÉCTRICO .....	63
<b>3</b>	ELECCIONES PARA LA INSTALACIÓN .....	55	<b>7</b>	COMPROBACIONES FINALES .....	64
<b>4</b>	CANALIZACIONES DE REGRIGERANTE .....	59			

## ÍNDICE

<b>1</b>	PRECAUÇÕES DE SEGURANÇA .....	66	<b>5</b>	EVACUAÇÃO .....	74
<b>2</b>	ACESSÓRIOS E REFRIGERANTE .....	67	<b>6</b>	LIGAÇÕES ELÉTRICAS .....	76
<b>3</b>	SELECÇÃO DA INSTALAÇÃO .....	68	<b>7</b>	VERIFICAÇÕES DE INSTALAÇÃO FINAIS .....	77
<b>4</b>	TUBAGEM DE REFRIGERANTE .....	72			

## INHOUD

<b>1</b>	VOORZORGSMAATREGELEN VOOR UW VEILIGHEID .....	79	<b>5</b>	ONTLUCHTEN .....	87
<b>2</b>	ACCESSOIRES EN KOELMIDDEL .....	80	<b>6</b>	ELEKTRISCH GEDEELTE .....	89
<b>3</b>	VOORBEREIDINGEN .....	81	<b>7</b>	LAATSTE CONTROLES VAN DE INSTALLATIE .....	90
<b>4</b>	KOELMIDDELLEIDINGEN .....	85			

## ΠΕΡΙΕΧΟΜΕΝΑ

<b>1</b>	ΠΡΟΦΥΛΑΞΕΙΣ ΑΣΦΑΛΕΙΑΣ .....	92	<b>5</b>	ΕΚΚΕΝΩΣΗ .....	100
<b>2</b>	ΠΑΡΕΛΚΟΜΕΝΟ ΚΑΙ ΨΥΚΤΙΚΟ .....	93	<b>6</b>	ΗΛΕΚΤΡΟΛΟΓΙΚΑ .....	102
<b>3</b>	ΕΠΙΛΟΓΗ ΕΓΚΑΤΑΣΤΑΣΗΣ .....	94	<b>7</b>	ΤΕΛΙΚΟΙ ΕΛΕΓΧΟΙ ΕΓΚΑΤΑΣΤΑΣΗΣ .....	103
<b>4</b>	ΣΩΛΗΝΩΣΕΙΣ ΨΥΚΤΙΚΟΥ .....	98			

ENGLISH

FRANCAIS

DEUTSCH

ITALIANO

ESPAÑOL

PORTUGUÊS

NEDERLANDS

ΕΛΛΗΝΙΚΑ

# 1 PRECAUTIONS FOR SAFETY

- Ensure that all Local, National and International regulations are satisfied.
- Read this "PRECAUTIONS FOR SAFETY" carefully before Installation.
- The precautions described below include the important items regarding safety. Observe them without fail.
- After the installation work, perform a trial operation to check for any problem.  
Follow the Owner's Manual to explain how to use and maintain the unit to the customer.
- Turn off the main power supply switch (or breaker) before the unit maintenance.
- Ask the customer to keep the Installation Manual together with the Owner's Manual.

## CAUTION

### New Refrigerant Air Conditioner Installation

- **THIS AIR CONDITIONER ADOPTS THE NEW HFC REFRIGERANT (R410A) WHICH DOES NOT DESTROY OZONE LAYER.**

The characteristics of R410A refrigerant are ; easy to absorb water, oxidizing membrane or oil, and its pressure is approx. 1.6 times higher than that of refrigerant R22. Accompanied with the new refrigerant, refrigerating oil has also been changed. Therefore, during installation work, be sure that water, dust, former refrigerant, or refrigerating oil does not enter the refrigerating cycle.

To prevent charging an incorrect refrigerant and refrigerating oil, the sizes of connecting sections of charging port of the main unit and installation tools are charged from those for the conventional refrigerant.

Accordingly the exclusive tools are required for the new refrigerant (R410A).

For connecting pipes, use new and clean piping designed for R410A, and please care so that water or dust does not enter. Moreover, do not use the existing piping because there are problems with pressure-resistance force and impurity in it.

## CAUTION

### To Disconnect the Appliance from Main Power Supply.

This appliance must be connected to the main power supply by means of a switch with a contact separation of at least 3 mm.

**The installation fuse (25A ) must be used for the power supply line of this conditioner.**

## ⚠ WARNING

- **Ask an authorized dealer or qualified installation professional to install/maintain the air conditioner.**  
Inappropriate installation may result in water leakage, electric shock or fire.
- **Turn off the main power supply switch or breaker before attempting any electrical work.**  
Make sure all power switches are off. Failure to do so may cause electric shock.
- **Connect the connecting cable correctly.**  
If the connecting cable is connected in a wrong way, electric parts may be damaged.
- **When moving the air conditioner for the installation into another place, be very careful not to enter any gaseous matter other than the specified refrigerant into the refrigeration cycle.**  
If air or any other gas is mixed in the refrigerant, the gas pressure in the refrigeration cycle becomes abnormally high and it may resultingly causes pipe burst and injuries on persons.
- **Do not modify this unit by removing any of the safety guards or by by-passing any of the safety interlock switches.**
- **Exposure of unit to water or other moisture before installation may cause a short-circuit of electrical parts.**  
Do not store it in a wet basement or expose to rain or water.
- **After unpacking the unit, examine it carefully if there are possible damage.**
- **Do not install in a place that might increase the vibration of the unit.**
- **To avoid personal injury (with sharp edges), be careful when handling parts.**
- **Perform installation work properly according to the Installation Manual.**  
Inappropriate installation may result in water leakage, electric shock or fire.

- **When the air conditioner is installed in a small room, provide appropriate measures to ensure that the concentration of refrigerant leakage occur in the room does not exceed the critical level.**
- **Install the air conditioner securely in a location where the base can sustain the weight adequately.**
- **Perform the specified installation work to guard against an earthquake.**  
If the air conditioner is not installed appropriately, accidents may occur due to the falling unit.
- **If refrigerant gas has leaked during the installation work, ventilate the room immediately.**  
If the leaked refrigerant gas comes in contact with fire, noxious gas may generate.
- **After the installation work, confirm that refrigerant gas does not leak.**  
If refrigerant gas leaks into the room and flows near a fire source, such as a cooking range, noxious gas might generate.
- **Electrical work must be performed by a qualified electrician in accordance with the Installation Manual. Make sure the air conditioner uses an exclusive power supply.**  
An insufficient power supply capacity or inappropriate installation may cause fire.
- **Use the specified cables for wiring connect the terminals securely fix. To prevent external forces applied to the terminals from affecting the terminals.**
- **Be sure to provide grounding.**  
Do not connect ground wires to gas pipes, water pipes, lightning rods or ground wires for telephone cables.
- **Conform to the regulations of the local electric company when wiring the power supply.**  
Inappropriate grounding may cause electric shock.
- **Do not install the air conditioner in a location subject to a risk of exposure to a combustible gas.**  
If a combustible gas leaks, and stays around the unit, a fire may occur.

**Required tools for installation work**

- |                            |                            |
|----------------------------|----------------------------|
| 1) Philips screw driver    | 10) Mega-tester            |
| 2) Hole core drill (65 mm) | 11) Electro circuit tester |
| 3) Spanner                 | 12) Hexagonal wrench       |
| 4) Pipe cutter             | 13) Flare tool             |
| 5) Knife                   | 14) Pipe bender            |
| 6) Reamer                  | 15) Level vial             |
| 7) Gas leak detector       | 16) Metal saw              |
| 8) Tape measure            |                            |
| 9) Thermometer             |                            |

**R410A (Special requirement)**

- 17) Gauge manifold  
(Charge hose : R410A special requirement)
- 18) Vacuum pump  
(Charge hose : R410A special requirement)
- 19) Torque wrench  
1/4 (17 mm) 16 N•m (1.6 kgf•m)  
3/8 (22 mm) 42 N•m (4.2 kgf•m)  
1/2 (26 mm) 55 N•m (5.5 kgf•m)  
5/8 (15.9 mm) 120 N•m (12.0 kgf•m)
- 20) Copper pipe gauge adjusting projection margin
- 21) Vacuum pump adapter

# 2 ACCESSORY AND REFRIGERANT

**Accessory and Installation Parts**

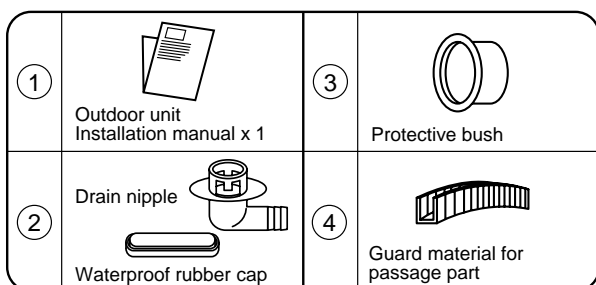

**Refrigerant Piping**

- Piping kit used for the conventional refrigerant cannot be used.
- Use copper pipe with 0.8 mm or more thickness for Ø9.5. Use copper pipe with 1.0 mm or more thickness for Ø15.9.
- Flare nut and flare works are also different from those of the conventional refrigerant. Take out the flare nut attached to the main unit of the air conditioner, and use it.

# 3 SELECTION OF INSTALLATION

## CAUTION

When using an air conditioner under low outside temperature condition (Outside temp.: -5°C or lower) with COOL mode, prepare a duct or wind shield so that it is not affected by the wind.

### <Example>

Suction hood (Rear side)

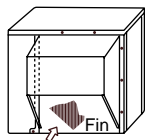

(Discharge upward/downward or leftward is also available.)

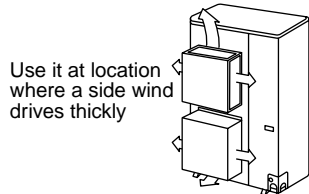

Suction hood (Side) Discharge hood

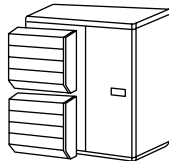
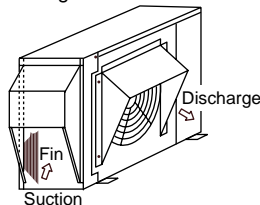

## Before installation

Be careful to the following items before installation.

### Length of refrigerant pipe

#### <SP1102AT-E, SP1402AT-E>

Length of refrigerant pipe connected to indoor/outdoor unit	Item
5m to 30m	Addition of refrigerant is unnecessary at the local site.
*31m to 70m	<Addition of refrigerant> Add 40g of refrigerant for every 1m of pipe which exceeds 30m.

#### \* Caution at addition of refrigerant

When the total length of refrigerant pipe exceeds 30m, add 40g/m of refrigerant and the maximum total length of pipe is 70m.

(Max. amount of additional refrigerant is 1600g.)

Charge the refrigerant accurately. Overcharge may cause a serious trouble of compressor.

### Air purge

- For air purge, use a vacuum pump.
- Do not use refrigerant charged in the outdoor unit for air purge. (The refrigerant for air purge is not contained in the outdoor unit.)

### Electrical cabling

- Be sure to fix the power cables and indoor/outdoor connecting cables with clamps so that they do not contact with the cabinet, etc.

## Installation Place

- A place which provides a specified space around the outdoor unit.
- A place where the operation noise and discharged air are not given to your neighbors.
- A place that is not exposed to a strong wind.
- A place that does not block a passage.
- When the outdoor unit is installed in an elevated position, be sure to secure its feet.
- There must be sufficient space for carrying in the unit.
- A place where the drain water does not make any problem.

## CAUTION

1. Install the outdoor unit at a place where discharge air is not blocked.
2. When an outdoor unit is installed in a place that is always exposed to a strong wind like a coast or on a high storey of a building, secure a normal fan operation by using a duct or a wind shield.
3. When installing the outdoor unit in a place that is constantly exposed to a strong wind such as the upper stairs or rooftop of a building, apply the windproof measures referring to the following examples.

- 1) Install the unit so that its discharge port faces to the wall of the building. Keep a distance 500 mm or more between the unit and the wall surface.

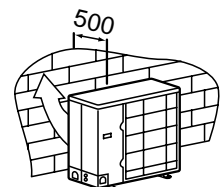

- 2) Supposing the wind direction during the operation season of the air conditioner, install the unit so that the discharge port is set at right angle to the wind direction.

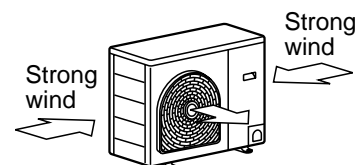

4. Installation in the following places may result in some troubles. Do not install the unit in such places below.

- A place full of machine oil.
- A place full of sulphuric gas.
- A place where high-frequency radio waves are likely to be generated as from audio equipment, welders, and medical equipment.

## Necessary Space for Installation

### Obstacle at rear side

#### <Upper side is free>

1. Single unit installation

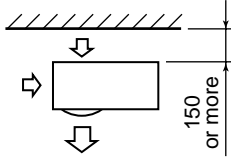

2. Obstacles at both right and left sides.

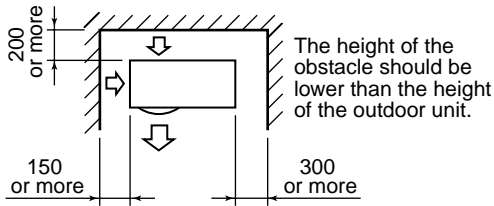

3. Serial installation of two or more units

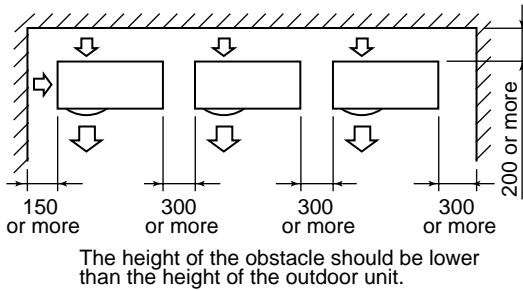

#### <Obstacle also at the upper side>

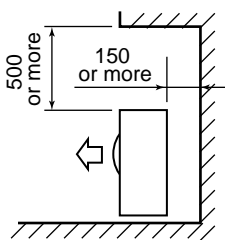

### Obstacle at front side

#### <Upper side is free>

1. Single unit installation

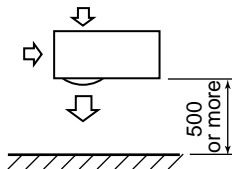

2. Serial installation of two or more units

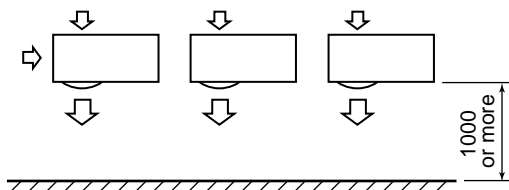

#### <Obstacle also at the upper side>

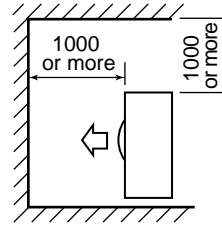

### Obstacles at both front and rear sides

Open the upper side and both right and left sides. The height of obstacle at both front and rear side, should be lower than the height of the outdoor unit.

#### <Standard installation>

1. Single unit installation

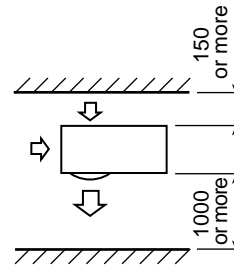

2. Serial installation of two or more units

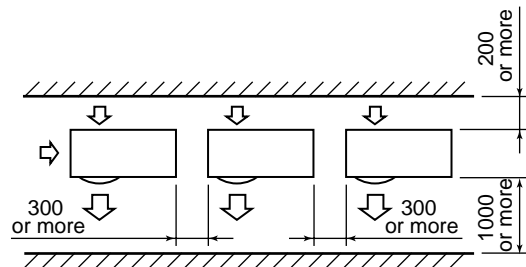

### Serial installation at front and rear sides

Open the upper side and both right and left sides. The height of obstacle at both front and rear sides should be lower than the height of the outdoor unit.

#### <Standard installation>

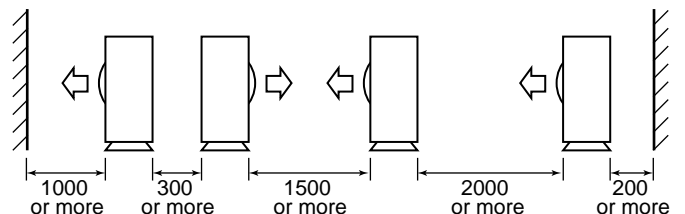

# 3 SELECTION OF INSTALLATION

## Installation of Outdoor Unit

- Before installation, check strength and horizontality of the base so that abnormal sound does not generate.
- According to the following base diagram, fix the base firmly with the anchor bolts.  
(Anchor bolt, nut: M10 x 4 pairs)

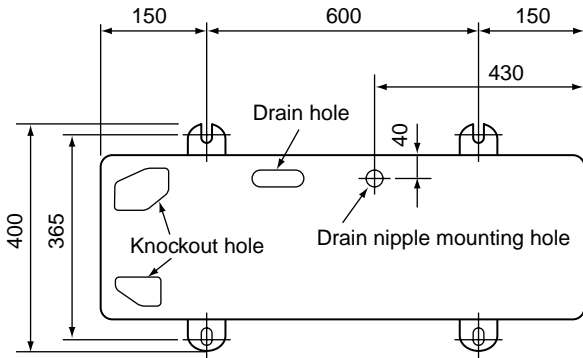

Set the out margin of the anchor bolt to 15mm or less.

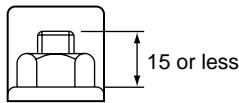

- In case of draining through the drain hose, attach the following drain nipple and the waterproof rubber cap, and use the drain hose (Inner diam.: 16mm) sold on the market. And also seal the screws securely with silicone material, etc. so that water does not drop down. Some conditions may cause dewing or dripping of water.

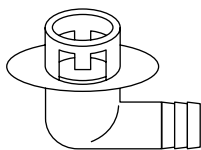

Drain nipple

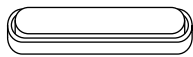

Waterproof rubber cap

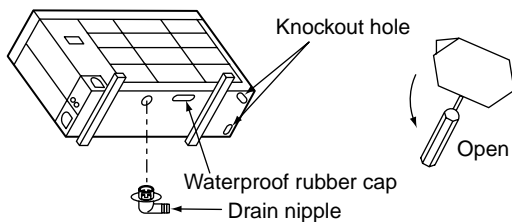

- When there is a possibility of freezing of drain at the cold district or a snowfall area, be careful for drainage ability of drain. The drainage ability increases when a knockout hole on the base plate is opened. (Open the knockout hole to outside using a screwdriver, etc.)

## Optional Installation Parts (Local Procure)

	Parts name	Q'ty
A	Refrigerant piping Liquid side : Ø9.5 mm Gas side : Ø15.9 mm	Each one
B	Pipe insulating material (polyethylene foam, 6 mm thick)	1
C	Putty, PVC tapes	Each one

## Refrigerant Piping Connection

### CAUTION

#### TAKE NOTICE THESE IMPORTANT 4 POINTS BELOW FOR PIPING WORK

1. Keep dust and moisture away from inside the connecting pipes.
2. Tightly connect the connection between pipes and the unit.
3. Evacuate the air in the connecting pipes using VACUUM PUMP.
4. Check gas leak at connected points.

### <Piping connection>

Liquid side		Gas side	
Outer diameter	Thickness	Outer diameter	Thickness
Ø9.5	0.8	Ø15.9	1.0

## For Reference

If a heating operation would be continuously performed for a long time under the condition that the outdoor temperature is 0°C or lower, draining of defrosted water may be difficult due to freezing of the bottom plate, resulting in a trouble of the cabinet or fan.

It is recommended to procure an anti-freeze heater locally for a safety installation of the air conditioner. For details, contact the dealer.



## Knockout of Pipe Cover

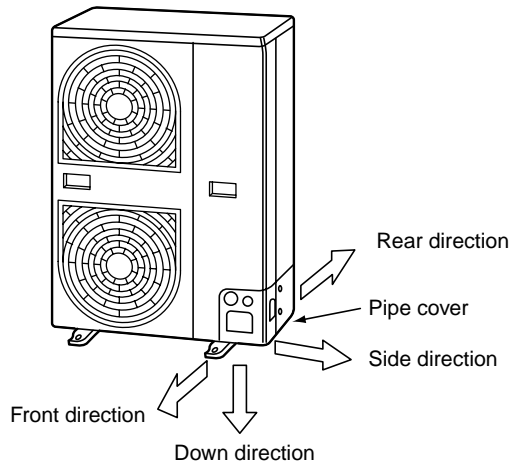

## Knockout procedure

- The indoor/outdoor connecting pipes can be connected to 4 directions.  
Take off the knockout part of the pipe cover in which pipes or wires pass through the base plate.
- As shown in the figure, do not remove the pipe cover from the cabinet so that the knockout hole can be easily punched. To knock out, it is easily taken off by hands by punching a position at the lower side of 3 connected parts with screwdriver along the guide line.
- After marking the knockout hole, remove the burr and mount the attached protective bush and guard material for pass-through part in order to protect pipes and wires.

After connecting the pipes, be sure to mount the pipe cover. The pipe cover is easily mounted by cutting off the slit at the lower part of the pipe cover.

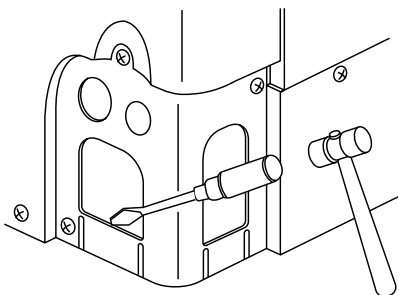

## How to remove the front panel

1. Remove screws of the front panel.
2. Pull the front panel downward.

Removing the front panel, the electric parts appear at the front side.

- The metal pipes are attachable to the piping holes. If the size of the used power pipe does not match with the hole, adjust the hole size to match with pipe size.
- Be sure to fix the power cable and indoor/outdoor connecting cable with bundling band sold on the market so that they do not make contact with the compressor and discharge pipe. (Temperature of the compressor and discharge pipe becomes high.)

In order to avoid the force applied to on the connecting section, be sure to fix the cables to the cord clamps provided on the pipe valve fixing plate and the electric parts box.

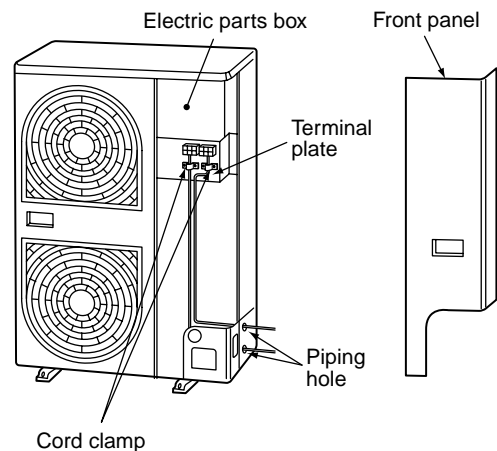

# 4 REFRIGERANT PIPING

## Pipe Forming/End Positioning

### Flaring

1. Cut the pipe with a pipe cutter.

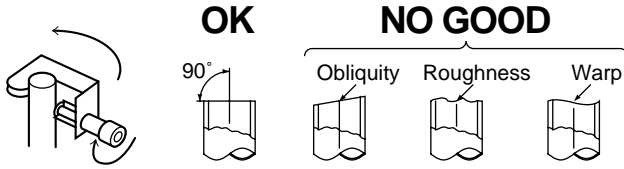

2. Insert a flare nut into the pipe, and flare the pipe.

As the flaring sizes of R410A differ from those of refrigerant R22, the flare tools newly manufactured for R410A are recommended.

However, the conventional tools can be used by adjusting projection margin of the copper pipe.

• Flaring size : A (Unit : mm)

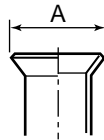

Outer dia. of copper pipe	A <sup>+0</sup> / <sub>-0.4</sub>	
	R410A	R22
6.4	9.1	9.0
9.5	13.2	13.0
12.7	16.6	16.2
15.9	19.7	19.4

\* In case of flaring for R410A with the conventional flare tool, pull it out approx. 0.5 mm more than that of R22 to adjust to the specified flare size. The copper pipe gauge is useful for adjusting projection margin size.

• Projection margin in flaring :  
B (Unit : mm)

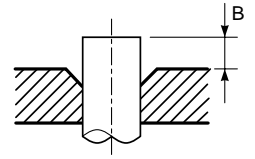

Rigid (Clutch type)

Outer dia. of copper pipe	R410A tool used		Conventional tool used	
	R410A	R22	R410A	R22
6.4	0 to 0.5	(Same as left)	1.0 to 1.5	0.5 to 1.0
9.5	0 to 0.5	(Same as left)	1.0 to 1.5	0.5 to 1.0
12.7	0 to 0.5	(Same as left)	1.0 to 1.5	0.5 to 1.0
15.9	0 to 0.5	(Same as left)	1.0 to 1.5	0.5 to 1.0

Imperial (Wing nut type)

Outer dia. of copper pipe	R410A	R22
6.4	1.5 to 2.0	1.0 to 1.5
9.5	1.5 to 2.0	1.0 to 1.5
12.7	2.0 to 2.5	1.5 to 2.0
15.9	2.0 to 2.5	1.5 to 2.0

## Tightening of Connecting Part

(Unit: N•m)

Outer dia. of copper pipe	Tightening torque
6.4 mm (diam.)	14 to 18 (1.4 to 1.8 kgf•m)
9.5 mm (diam.)	33 to 42 (3.3 to 4.2 kgf•m)
12.7 mm (diam.)	50 to 62 (5.0 to 6.2 kgf•m)
15.9 mm (diam.)	68 to 82 (6.8 to 8.2 kgf•m)

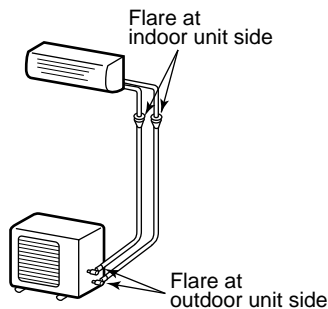

- Align the centers of the connecting pipes and tighten the flare nut strong as far as possible with your fingers.

Then fix the nut with a spanner and tighten it with torque wrench as shown in the figure.

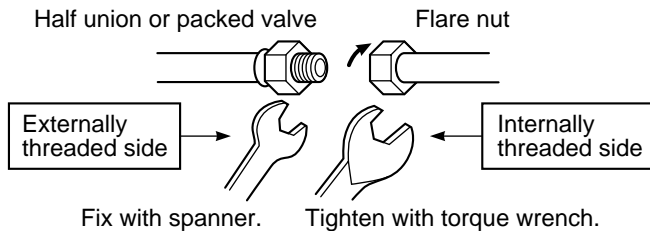

- As shown in the figure, be sure to use a double spanner to loosen or tighten the flare nut of the valve at gas side. If using a single spanner, the nut cannot be tightened with necessary tightening torque. On the contrary, use a single spanner to loosen or tighten the flare nut of the valve at liquid side.

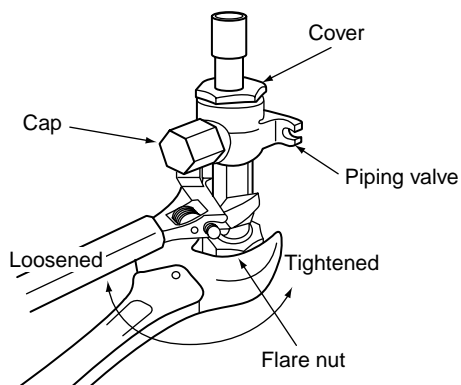

Valve at gas side

## REQUIREMENT

- Do not put the spanner on the cap. The valve may be broken.
  - If applying excessive torque, the nut may be broken according to some installation conditions.
- After the installation work, be sure to check gas leak of connecting part of the pipes with nitrogen.

## NO GOOD

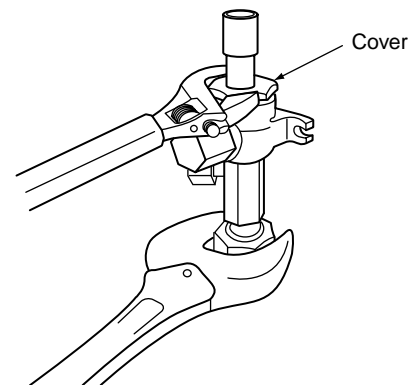

- Pressure of R410A is higher than that of R22 (Approx. 1.6 times). Therefore, using a torque wrench, tighten the flare pipe connecting sections which connect the indoor/outdoor units at the specified tightening torque. Incomplete connections may cause not only a gas leak, but also a trouble of the refrigeration cycle.

**Do not apply refrigerating machine oil to the flared surface.**

# 5 EVACUATING

## Air Purge

This air conditioner can be installed up to the connecting pipe length and height difference in the following table.

Capacity rank RAV-	Max. connecting pipe length (m)	Height difference (m)		Hexagonal wrench size
		Outdoor unit at upper side	Outdoor unit at lower side	
SP1102, SP1402 type	70	30	15	4mm

With respect to the preservation of terrestrial environment, adopt "Vacuum pump" for air purge (Evacuate air in the connecting pipes) when installing the unit.

- Do not discharge the refrigerant gas to the atmosphere to preserve the terrestrial environment.
- Use a vacuum pump to discharge the air (nitrogen, etc.) remained in the set. If the air remains, the capacity may decrease.

For the vacuum pump, be sure to use one with backflow preventer so that the oil in the pump does not backflow into the pipe of the air conditioner when the pump stops. (If oil in the vacuum pump is put in an air conditioner including R410A, it may cause trouble on the refrigeration cycle.)

## Vacuum pump

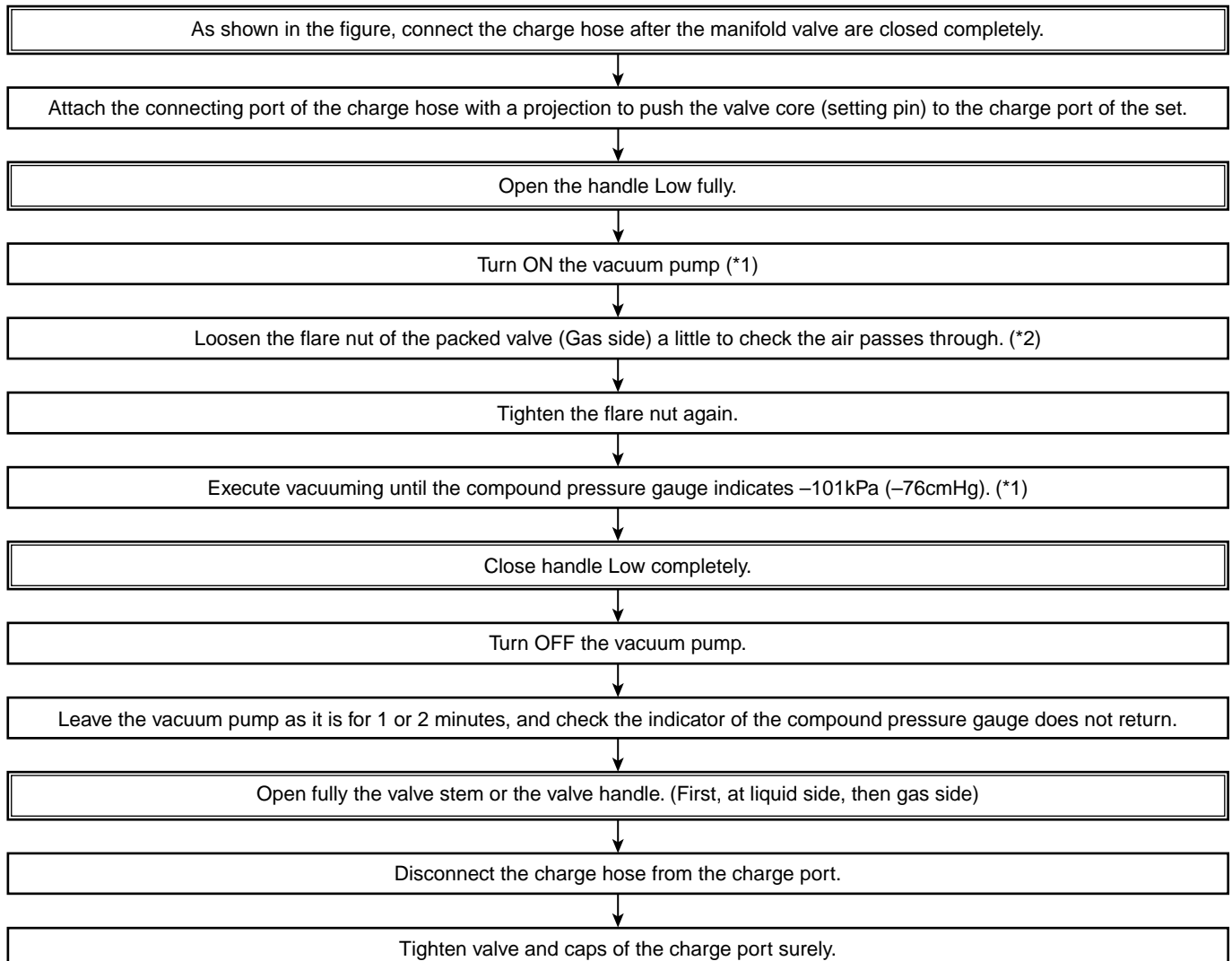

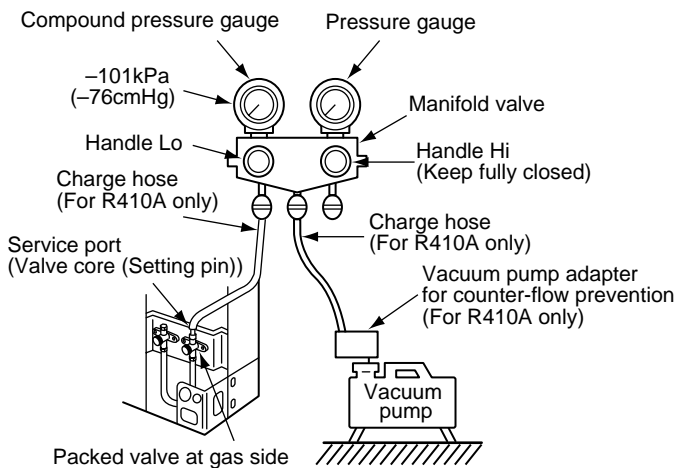

**<TYPE 2>**

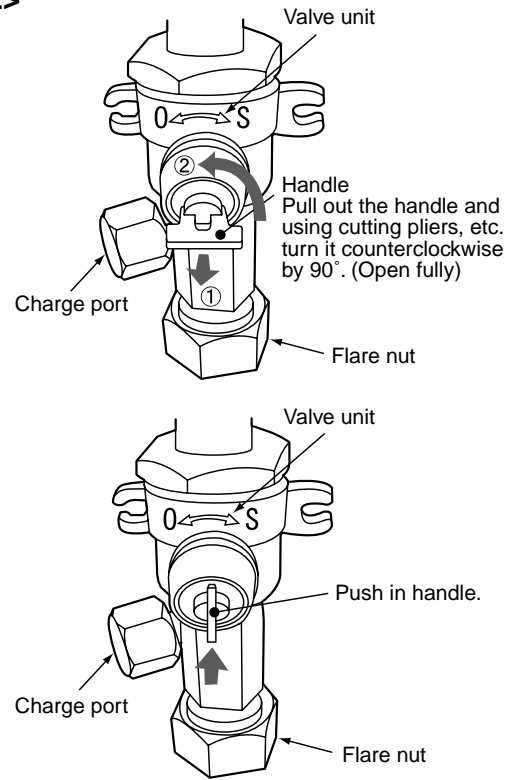

**How to open the valve**

Two types of valves are provided to the gas side. Refer to the corresponding one.

**<TYPE 1>**

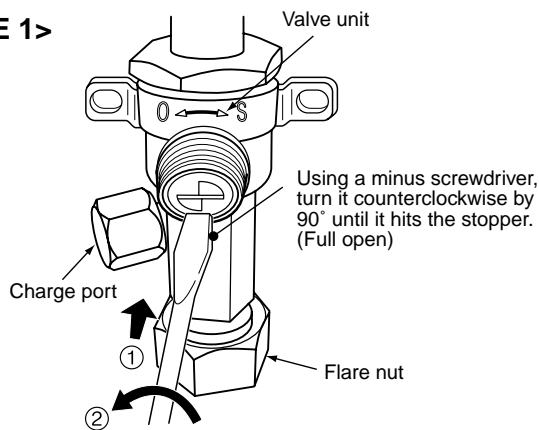

**Handle position**

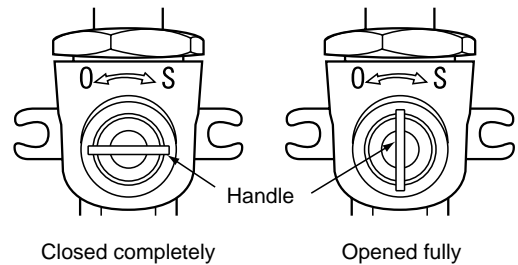

**Position of grooves for driver**

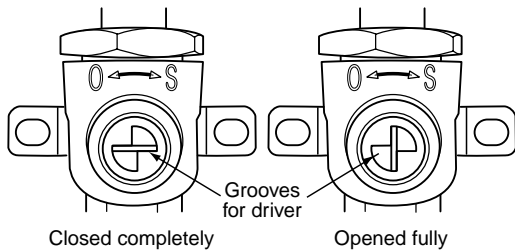

\*1. When opened fully, do not apply an excessive torque after the screwdriver hit the stopper; otherwise a trouble may be caused on the valve.

- \*1. Use the vacuum pump, vacuum pump adapters, and gauge manifold referring to the manuals attached to each tool before using them. For the vacuum pump, check oil is filled up to the specified line of the oil gauge.
- \*2. While the air is purged, check again that the connecting port of charge hose, which has a projection to push the valve core, is firmly connected to the charge port.

**Valve handling precautions**

- Open the valve stem or the handle until it strikes the stopper. It is unnecessary to apply further force.
- Securely tighten the cap with a torque wrench.
- Cap tightening torque

Valve size	Ø6.4	14 to 18N•m (1.4 to 1.8kgf•m)
	Ø9.5	33 to 42N•m (3.3 to 4.2kgf•m)
	Ø12.7	33 to 42N•m (3.3 to 4.2kgf•m)
	Ø15.9 (TYPE 1)	14 to 18N•m (1.4 to 1.8kgf•m)
	Ø15.9 (TYPE 2)	20 to 25N•m (2.0 to 2.5kgf•m)
Charge port		14 to 18N•m (1.4 to 1.8kgf•m)

# 6 ELECTRICAL WORK

For the air conditioner that has no power cable, connect a power cable as mentioned below.

## Stripping length power cord and connecting cable

Model	RAV-	SP1102AT-E, SP1402AT-E
Power supply		220 – 240 V Single phase 50 Hz
Maximum running current		22.8 A
Installation fuse rating		25 A (all types can be used)
Power cable		H07 RN-F or 60245 IEC 66 (2.5 mm <sup>2</sup> or more)

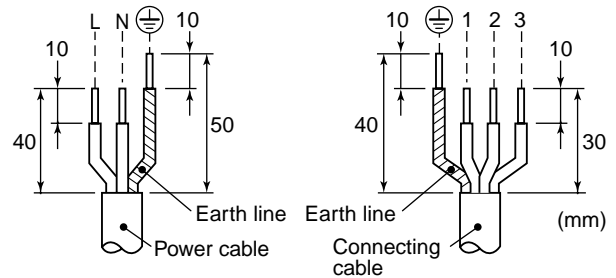

### CAUTION

- Wrong wiring may cause a burn-out to some electrical parts.
- Be sure to use the cord clamps attached to the product.
- Do not damage or scratch the conductive core and inner insulator of power and inter-connecting cables when peeling them.
- Be sure to comply with local regulations of the cable from outdoor unit to indoor unit. (wire size and cabling method etc.)
- Use the power and Inter-connecting cables with specified thickness, specified type and protective devices required.

### CAUTION

- The installation fuse (25A) must be used for the power supply line of this air conditioner.
- Incorrect/incomplete wiring might cause an electrical fire or smoke.
- Prepare the exclusive power supply for the air conditioner.
- This product can be connected to the mains.  
Connection to the fixed wiring :  
A switch which disconnects all poles and has a contact separation of at least 3 mm must be incorporated in the fixed wiring.

## How to wire

1. Connect the connecting cable to the terminal as identified with their respective numbers on the terminal block of indoor and outdoor unit.  
H07 RN-F or 60245 IEC 66 (1.5 mm<sup>2</sup> or more)
2. When connecting the connecting cable to the outdoor unit terminal, prevent water coming in the outdoor unit.
3. Insulate the unsheathed cords (conductors) with electrical insulation tape. Process them so that they do not touch any electrical or metal parts.
4. For inter connecting cable, do not use a wire jointed to another on the way.

Use wires long enough to cover the entire length.

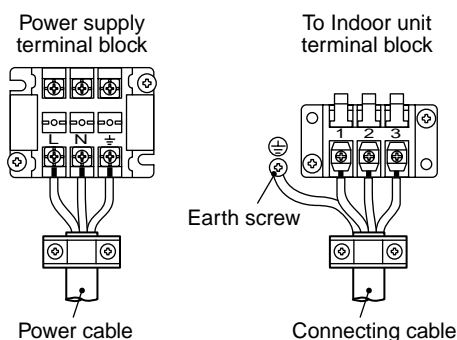

# 7 FINAL INSTALLATION CHECKS

## Check and Test Operation

For R410A, use the leak detector exclusively manufactured for HFC refrigerant (R410A, R134a, etc.).

- \* The conventional leak detector for HCFC refrigerant (R22, etc.) cannot be used because its sensitivity for HFC refrigerant lowers to approx. 1/40.
- Pressure of R410A is approx. 1.6 times higher than that of R22.  
If installation work is incompletely finished, a gas leakage may occur when pressure rises during operation. Therefore, be sure to test the piping connections for leakage.
- Check gas leakage at the flare nut connections, valve stem cap connections and service port cap fittings with a leak detector or soap water.

## CAUTION

When the remote controller is used for the first time, it accepts an operation approx. 5 minutes after the power supply has been turned on.

It is not a trouble, but is because the setup of the remote controller is being checked.

For the second power-ON time and after, approx. 1 minute is required to start the operation by the remote controller.

## Useful Functions

## Self-Diagnosis by LED Indication

In addition to the code checking by remote controller of the indoor unit, troubles of the outdoor unit can be diagnosed by LED indications on the cycle control P.C. board of the outdoor unit. Utilize them for various checks. For the check by remote controller of the indoor unit, refer to the Installation Manual of the indoor unit. Before a check, confirm each bit of the DIP switch SW800 is set to OFF position.

### LED indication and code checking

LED indication	Cycle control P.C. board				Cause
	LED indication				
	D800	D801	D802	D803	
D800 ○ : Red D801 ○ : Yellow D802 ○ : Yellow D803 ○ : Yellow  ◎ : Rapid flash ● : Go off ○ : Go on	○	●	●	●	Heat exchanger sensor (TE) error
	●	●	○	●	Suction sensor (TS) error
	○	○	●	●	Discharge sensor (TD) error
	●	○	●	○	High-pressure protection error
	●	○	●	●	Outdoor temperature sensor (TO) error
	○	○	○	●	DC outside fan error
	○	●	●	○	Communication error between IPDU (Abnormal stop)
	●	○	●	○	High-pressure release operation
	●	○	○	●	Discharge temp. error
	○	○	●	○	EEPROM error
	●	●	○	○	Communication error between IPDU (No abnormal stop)
	◎	●	●	●	G-Tr short-circuit protection
	●	◎	●	●	Detect circuit error
	◎	◎	●	●	Current sensor error
	●	●	◎	●	Comp. lock error
◎	●	◎	●	Comp. break down	

# 7 FINAL INSTALLATION CHECKS







## Installation/Serviceing Tools

## Changes in the product and components

In the case of an air conditioner using R410A, in order to prevent any other refrigerant from being charged accidentally, service port diameter of the outdoor unit control valve (3 way valve) has been changed. (1/2 UNF 20 threads per inch)

- In order to increase the pressure resisting strength of the refrigerant piping flare processing diameter and size of opposite side of flare nuts has been changed. (for copper pipes with nominal dimensions 1/2 and 5/8)

### New tools for R410A

New tools for R410A	Applicable to R22 model		Changes
Gauge manifold	×		As pressure is high, it is impossible to measure by means of conventional gauge. In order to prevent any other refrigerant from being charged, each port diameter is changed.
Charge hose	×		In order to increase pressure resisting strength, hose materials and port size are changed (to 1/2 UNF 20 threads per inch). When purchasing a charge hose, be sure to check the port size.
Electronic balance for refrigerant charging	○		As pressure is high and gasification speed is fast, it is difficult to read the indicated value by means of charging cylinder, as air bubbles occur.
Torque wrench (nominal diam. 1/2, 5/8)	×		The size of opposite sides of flare nuts have been increased. Incidentally, a common wrench is used for nominal diameters 1/4 and 3/8.
Flare tool (clutch type)	○		By increasing the clamp bar's receiving hole, strength of spring in the tool has been improved.
Gauge for projection adjustment	—	—	Used when flare is made with using conventional flare tool.
Vacuum pump adapter	○		Connected to the conventional vacuum pump. It is necessary to use an adapter to prevent vacuum pump oil from flowing back to the charge hose. The charge hose connecting part has two ports-one for conventional refrigerant (7/16 UNF 20 threads per inch) and one for R410A. If the vacuum pump oil (mineral) mixes with R410A a sludge may occur and damage the equipment.
Gas leakage detector	×		Exclusive for HFC refrigerant.

- Incidentally, the “refrigerant cylinder” comes with the refrigerant designation (R410A) and protector coating in the U.S.'s ARI specified rose color (ARI color code: PMS 507).
- Also, the “charge port and packing for refrigerant cylinder” require 1/2 UNF 20 threads per inch corresponding to the charge hose's port size.