

# TOSHIBA

## REMOTE CONTROLLER FOR AIR CONDITIONER (SPLIT TYPE)

# Owner's Manual

### Remote Controller

Model name:

Wireless Remote Controller Kit

RBC-AX31U(W)-E

RBC-AX31U(WS)-E

Generic model name	Wireless remote controller and signal receiving part
RBC-AX31U(W)-E RBC-AX31U(WS)-E	WH-H1JE2 (Wireless remote controller model name)

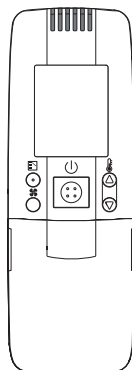

Wireless remote controller  
(WH-H1JE2)

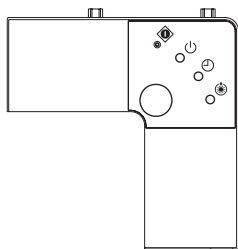

Signal receiving  
part

Owner's Manual Remote controller for air conditioner (Split type)	1	English
Manuel du propriétaire Télécommande pour climatiseur (Type split)	15	Français
Betriebsanleitung Fernbedienung für Klimagerät (Split-typ)	29	Deutsch
Manuale del proprietario Telecomando per condizionatore d'aria (Tipo split)	43	Italiano
Manual del propietario Control remoto para aire acondicionado (Tipo split)	57	Español
Manual do utilizador Controlador remoto para ar condicionado (Tipo split)	71	Português
Gebruiksaanwijzing Afstandsbediening voor airconditioner (Gesplitst type)	85	Nederlands
Εγχειρίδιο χρήσης Τηλεχειριστήριο για κλιματιστικό (ΤυΠου split)	99	Ελληνικά
Руководство пользователя Пульт дистанционного управления для кондиционера (Сплит-системы)	113	Русский
Kullanım Kılavuzu Klima İçin uzaktan kumanda (Split tip)	127	Türkçe

- Please read this Owner's Manual carefully for correct use before using your Wireless Remote Controller Kit. Be sure to read "PRECAUTIONS FOR SAFETY"
- After you read this manual, please keep it with the Owner's Manual of the air conditioner in a place where you can access it quickly.

## Contents

---

<b>1</b>	<b>PRECAUTIONS FOR SAFETY</b>	<b>2</b>
<b>2</b>	<b>PART NAMES AND FUNCTIONS</b>	<b>3</b>
<b>3</b>	<b>HOW TO OPERATE INDOOR UNIT</b>	<b>7</b>
<b>4</b>	<b>HOW TO OPERATE THE TIMER</b>	<b>8</b>
<b>5</b>	<b>HOW TO ADJUST AIR DIRECTION</b>	<b>9</b>
<b>6</b>	<b>SLIDE SWITCH</b>	<b>10</b>
<b>7</b>	<b>HOW TO INSERT BATTERIES</b>	<b>10</b>
<b>8</b>	<b>HOW TO HANDLE THE REMOTE CONTROLLER</b>	<b>11</b>
<b>9</b>	<b>NOTES ON PROPER USE</b>	<b>11</b>
<b>10</b>	<b>ADDRESS</b>	<b>12</b>
<b>11</b>	<b>HOW TO PERFORM EMERGENCY OPERATION</b>	<b>13</b>
<b>12</b>	<b>BEFORE ASKING FOR REPAIR WORK</b>	<b>14</b>

# 1 PRECAUTIONS FOR SAFETY

## WARNING

### WARNINGS ABOUT INSTALLATION

- Make sure to ask the qualified installation professional in electric work to install the remote controller.  
If the remote controller is inappropriately installed by yourself, it may cause electric shock or fire, etc.
- Make sure to install the air conditioner specified by TOSHIBA and ask the exclusive dealer when installing. If the air conditioner is installed by yourself, it may cause electric shock or fire, etc.

### WARNINGS ABOUT OPERATION

- Prevent any liquid from falling into the remote controller.  
Do not spill juice, water or any kind of liquid.  
It may cause machine failure, electric shock or fire, etc.
- When you are aware of something abnormal with the air conditioner (smells like something burning, etc.), immediately turn off the main power supply switch or circuit breaker to stop the air conditioner, and make contact with the dealer.  
If the air conditioner is continuously operated with something abnormal, it may cause machine failure, electric shock or fire, etc.

### WARNINGS ABOUT MOVEMENT AND REPAIR

- Do not repair any unit by yourself.  
Whenever the air conditioner needs repair, make sure to ask the dealer to do it.  
If it is repaired imperfectly, it may cause electric shock or fire, etc.
- When reinstalling the air conditioner, contact with the dealer.  
If the installation is insufficient, it may cause electric shock or fire, etc.

## CAUTION

### CAUTIONS ABOUT INSTALLATION

- Do not install the remote controller in a place where its signals do not reach the indoor unit.
- Do not install the remote controller in the place under the direct sunlight and close to any heat source. It may cause machine failure.
- The fluorescent lamp with rapid start system or inverter system may disturb the signal reception. For details, contact with the dealer of the air conditioner you have purchased.

### CAUTIONS ABOUT OPERATION

- Do not drop or apply strong shock to the air conditioner.  
It may cause remote controller failure.
- Use batteries that meet the specifications.

## 2 PART NAMES AND FUNCTIONS

### ■ Remote Controller (WH-H1JE2)

- Up to 8 indoor units in a group can be controlled by one remote controller.

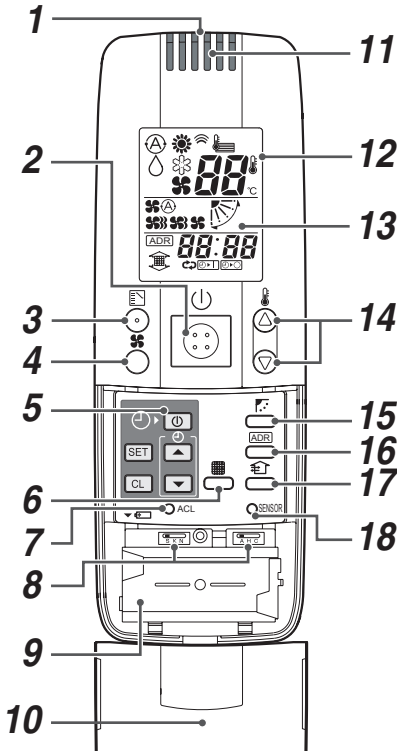

- 1 Transmitting part**
- 2 Start/Stop button**  
Starts and stops the air conditioner alternately.
- 3 Mode select button**  
Selects an operation mode.
- 4 Air volume button**
- 5 Time setup button**  
Used for timer setting. (See page 8)
- 6 Filter button**  
No function
- 7 RESET button**  
Used after batteries are replaced or the slide switch is switched. (See page 10)
- 8 Slide switch (See page 10)**
- 9 Battery compartment (See page 10)**
- 10 Cover**  
Slide the cover downward holding its both sides.
- 11 Remote controller sensor**  
Senses the ambient temperature when the remote controller is selected with the sensor button.
- 12 Operation mode display**  
Displays the air conditioner operation mode. (This illustration shows all display contents.)
- 13 AUTO louver display differs according to the installed unit. (See page 9)**
- 14 Setup temperature button**  
Every pushing this button, temperature rises by 1°C.  
Every pushing this button, temperature lowers by 1°C.
- 15 Swing/air direction button (See page 9)**
- 16 Address button (See page 12)**
- 17 Ventilation button**  
The remote controller is not operated even if this switch is pushed. (no function)
- 18 Sensor button**  
Selects the temperature sensor of the remote controller.  
The temperature sensor of the indoor unit is selected by default. While the indoor unit temperature sensor is selected,  is displayed on the display.

## ■ Signal Receiving Part

- The signal receiving part is attached to the indoor unit.
- Hereinafter, all remote controller button names are indicated with respective symbols displayed on the remote controller.

Example: Start/Stop button → 

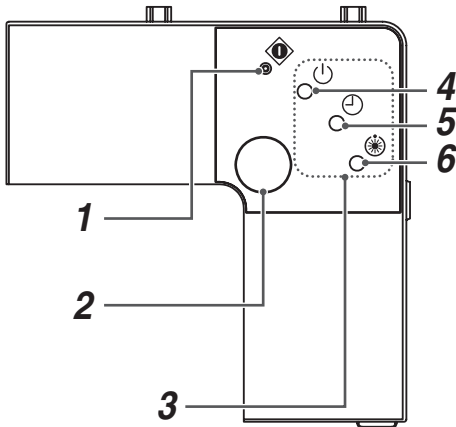

### 1 Emergency operation button (See page 13)

### 2 Signal receiver

Receives signals from the remote controller.

### 3 LEDs

Any of these LEDs flashes during an error state.

When an LED flashes, see “BEFORE ASKING FOR REPAIR WORK” on page 14.

### 4 Run LED (green)

Lights while the air conditioner is working.

### 5 Timer LED (green)

Lights while the timer is reserved.

### 6 Not Ready LED (orange)

- Lights in the heating mode at the beginning of operation or during defrosting or when the temperature controller is activated.
- Flashes during an error state.

## The rear of signal receiving part

The following switches are provided on the rear of the signal receiving part. For their settings, contact the dealer from whom you purchased the air conditioner.

### • Header/follower switch

Normally, set this switch to “HEADER” to use the remote controller as a header.

The remote controller can be used together with the wired remote controller (sold separately).

### • Test run switch



Do not use this switch in normal operation, but use for service.

### • Address switches (See page 12)

Distinguish transmit signals and receive signals.



## CAUTION

- If “pi, pi” sound is heard with the Run LED lighting and the Timer and Not Ready LEDs flashing alternately while the heat-pump type air conditioner is used, desired operation mode is disabled. The same is true if the AUTO mode is selected in a model that is not provided with the cool/heat auto function.
- Even if you push ,  or  when remote controller operation is disabled by the central control or other means, “pi” is heard 5 times and the button operation is not accepted.

## ■ Display section

All indicators are shown in the right and the lower figures for the explanation.

Only selected contents are display in actual operation.

- When turning on the leak breaker at the first time, [SET DATA] flashes on the display part of the remote controller. While this display is flashing, the model is being automatically confirmed.

Accordingly, wait for a while after [SET DATA] display has disappeared, and then use the remote controller.

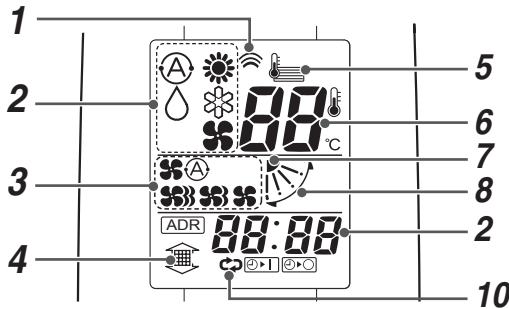
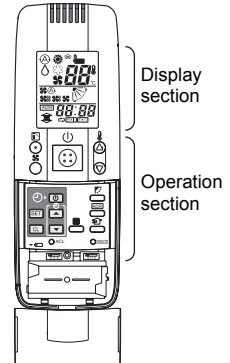

### 1 Transmitting indication

Displayed while operating the switches of the remote controller.

### 2 Mode display

The selected operation mode is displayed.

### 3 Fan mode select display

The selected fan mode is displayed.

- (AUTO)
- (HIGH)
- (MED.)
- (LOW)

### 4 Filter display

If "FILTER " is displayed, clean the air filter.

### 5 CHECK display

Displayed while the protective device works or a trouble occurs.

### 6 Set up temperature display

The selected set up temp. is displayed.

### 7 Louver position display

Displays louver position.

### 8 SWING display

Displayed during up/down movement of the louver.

### 9 Timer time display

Time of the timer is displayed.

(When a trouble occurs, the check code is displayed.)

### 10 Timer SET IN setup display

When pushing the Timer SET IN button, the display of the timer is selected in order of [OFF] → [OFF] repeat OFF timer → [ON] → No display.

## ■ Operation section

Push each button to select a desired operation.

- The details of the operation needs to be set up once, afterward, the air conditioner can be used by pushing ON/OFF (⏻) only.

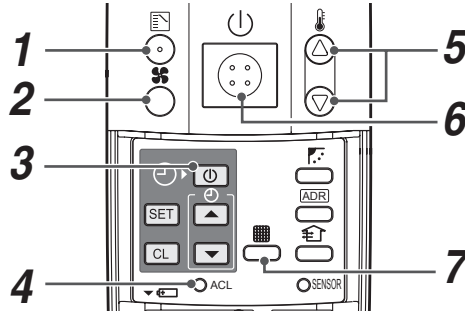

### 1 Operation select button

Selects the desired operation mode.

### 2 Fan mode select button

Selects a fan mode.

### 3 Time setup button

Used for timer setting. (See page 8)

### 4 Check button

The CHECK button is used for the check operation. During normal operation, do not use this button.

### 5 Temperature set button

Adjusts the room temperature.

Set the desired set temperature by pushing (▲) or (▼).

### 6 Start/Stop button

When the button is pushed, the operation starts, and it stops by pushing the button again.

When the operation has stopped, the operation lamp and all the displays disappear.

### 7 Filter button

Resets (Erases) "FILTER" (🌀) display.

### OPTION :

#### Remote controller sensor

Usually the temperature sensor of the indoor unit senses the temperature.

The temperature on the surrounding of the remote controller can also be sensed.

For details, contact the dealer from which you have purchased the air conditioner.

## 3 HOW TO OPERATE INDOOR UNIT

### ■ Auto, Heat, Dry, Cool, Fan

- The automatic cooling/heating and heating functions are not provided for cool-only types.
- The automatic cooling/heating is not available for heat pump types that are not provided with the automatic cooling/heating function.

### Power

Turn on the power switch on the remote controller 12 hours before starting operation.

- \* The remote controller is disabled for approx. 1 minute after the indoor unit has been powered on. This is normal. (The signal from the remote controller is received, but the receive data is discarded.)

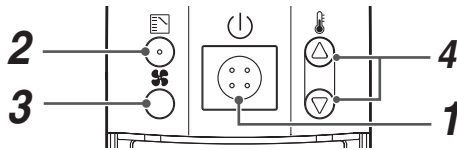

- 1 Push .
- 2 Push to select an operation mode.
  - Select Auto, Heat, Dry, Cool, or Fan.
- 3 Push to select a fan speed.
  - When the Auto mode is selected, the fan speed changes automatically. The fan speed does not change automatically in the Fan mode.
- 4 Push either button of to select the desired temperature.
  - Temperature setting is not available for the Fan mode.

### 5 Stop

Push .

When the operation is stopped with the remote controller, the outdoor unit fan keeps running in some cases even after the compressor of the outdoor unit has stopped.

- **If the room is not well heated with FAN during heating, change the fan speed to FAN or FAN .**  
Although selected fan speed is displayed, some indoor unit types are not provided with the air volume change function. (Fan speed is constant.)
- **If the unit operation cannot be stopped in the usual manner, turn off the power switch and contact the dealer from whom you purchased the air conditioner.**

### ■ Automatic Cooling/Heating

When all indoor units in the same refrigerant system are under the group control, heating or cooling operation is automatically performed according to the difference between the setup temperature and the room temperature.

### ■ Self cleaning

The self cleaning operation starts automatically after running the cooling/dry mode (10 minutes or more) to keep the inside of the indoor unit clean. (For details, refer to the Owner's Manual of the indoor unit.)

To stop self cleaning forcibly, push twice quickly.



## 4 HOW TO OPERATE THE TIMER

- After the timer has been set, put the remote controller at a position where signals of the remote controller can reach the signal receiver on the indoor unit. The timer operation signal is transmitted from the remote controller.
- Set the timer while an operation mode is displayed as follows:

Use the timer in the following cases		Mode displayed
To stop the air conditioner when the preset time has passed	OFF timer	
To stop the air conditioner each time when the preset time has passed	Repeat OFF timer	
To operate the air conditioner when the preset time has passed	ON timer	

### Timer period

The setup time increases by 0.5 hours (30 minutes) each time you push . The maximum setup time is 72.0 hours. The setup time decreases by 0.5 hours (30 minutes) each time you push . The minimum setup time is 0.5 hours.

### Timer display

Each time you push Timer , the timer display changes as follows:

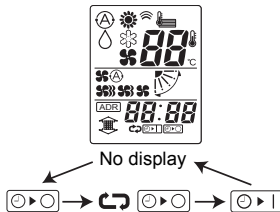

### <Usage Examples>

#### ▼ Setting OFF timer

(Example) To stop operation in 30 minutes

- 1 Push Timer .  
 and the time flash on the display.
- 2 Set the time to 0.5 with TIME or .
- 3 Push . and the time stop flashing.

#### ▼ Setting repeat OFF timer

(Example) To stop operation in every 2.5 hours

- 1 Push Timer twice.  
 and the time flash on the display.
- 2 Set the time to 2.5 with TIME or .
- 3 Push . and the time stop flashing.

The OFF timer is activated and the operation stops in 2.5 hours. When you push again to restart the operation, it stops in 2.5 hours.

#### ▼ Setting ON timer

(Example) To start operation in 8 hours

- 1 Push Timer three times.  
 and the time flash on the display.
- 2 Set the time to 8.0 with TIME or .
- 3 Push .

The operation mode disappears, and and the time stop flashing.

#### ▼ Canceling timer operation

Push . The timer display disappears.

## 5 HOW TO ADJUST AIR DIRECTION

- While the air conditioner is not working, the louver (air direction adjusting plate) is closed automatically.
- During the preparation for heating, the louver is directed upward and it starts swinging after the preparation for heating is canceled though the automatic louver display on the remote controller shows swinging even during this period.

### To set air direction



Push  during operation. Air direction changes each time you push the button.

### **Heating mode**

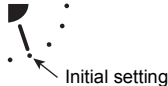
Keep the louver pointed downward so that discharged hot air reaches the floor.



### To start swinging



Push  to set the louver direction to the lowest, and then push  again. Louver swinging appears on the display and air direction automatically changes up and down.

### **Cooling/dry mode**

Keep the louver pointed upward. Otherwise, dew drop may form around the discharge port and drop from the unit.



### To stop swinging

Push  once again while the louver is swinging. The louver can be stopped at a desired position. Then air direction can be set again from the uppermost by pushing .

- \* The louver does not stop while it is pointed downward during cooling or drying. Even if you attempt to stop the louver with the louver pointed downward during swinging, it stops at the third position from the uppermost direction.

### **Fan mode**



### **All operation modes**



### **Display when swinging is stopped**

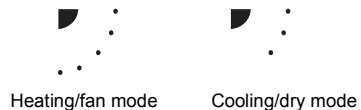

- This remote controller has no function to set air direction individually or power-saving operation or to change the swing mode that are described in the Owner's Manual of the indoor unit.

## 6 SLIDE SWITCH

- The settings of operation mode display and air direction display vary as follows depending on the indoor unit in use.
- Use a fine-tipped tool to change the switch setting.
- Push the RESET button after the switch setting is changed.

### 1 Louver display switch

Louver display of the remote controller	
Slide switch position	

- \* Set the slide switch to "S." Otherwise the air direction adjustment and louver display are disabled.

View with the cover removed

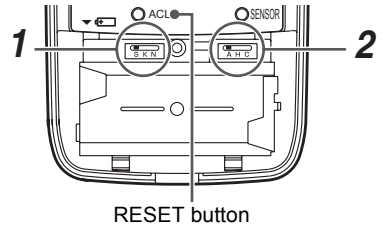

### 2 Operation mode switch

	Heat pump (With automatic cooling/heating)	Heat pump (Without automatic cooling/heating)	Cool-only
Operation mode display of the remote controller			
Slide switch position			

- Before using the air conditioner, check that the slide switch is set as shown in this table. For details of slide switch setting, contact the dealer from whom you purchased the air conditioner.

## 7 HOW TO INSERT BATTERIES

- 1 Slide and remove the cover downward while holding both sides of the cover.
- 2 Insert two AAA alkaline batteries correctly matching the (+) and (-) polarities with the indication.
- 3 Push the RESET button with a fine-tipped tool and attach the cover.
  - Replace batteries when the display on the remote controller has become dim or when signals from the remote controller cannot be received at the normal distance from the signal receiving part. Alkaline batteries should be replaced once a year.
  - Replace two batteries at the same time with new ones of the same type.
  - When you do not use the remote controller for a long time, take out the batteries.
  - Discard exhausted batteries at a designated place.

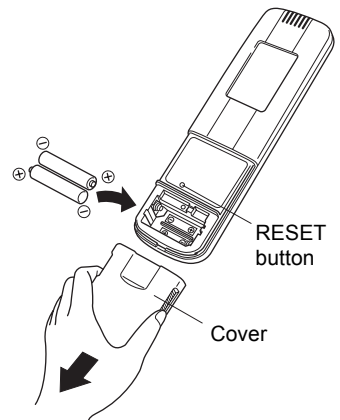

## 8 HOW TO HANDLE THE REMOTE CONTROLLER

- Point the transmitting part of the remote controller at the signal receiving part of the indoor unit. When a signal is received normally, “pi” sound is heard once. (“Pi, pi” is heard only at the beginning of operation.)
- The standard signal receivable distance from the signal receiving part of the indoor unit is approx. 7 m. The distance varies somewhat with the battery capacity or other conditions.
- Do not put anything that blocks signals between the remote controller and the signal receiving part of the indoor unit.
- Do not put the remote controller at a place exposed to direct sunlight or air from the indoor unit or near a heater.
- Do not drop or throw the remote controller or wipe it with water.
- Signals from the remote controller may not be accepted in a room equipped with a rapid start-type or inverter-type fluorescent light. For details, contact the dealer from whom you purchased the air conditioner.

### ■ To set the Remote Controller on the Wall

- Push (⏏) at the installation position on the wall to check that the signal from the remote controller is received correctly.
- To take the remote controller out of the holder, pull it toward you.

Fix the remote controller holder with screws.

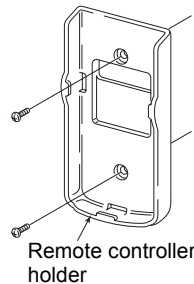

Setting the remote controller into the holder

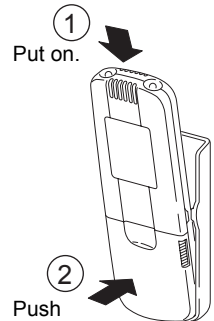

## 9 NOTES ON PROPER USE

- Put the remote controller within the specified distance from the signal receiving part of the indoor unit.  
Failure to do so may result in malfunction.  
Be sure to put the remote controller in a room where the indoor unit is installed.
- When pushing a button on the remote controller, point the remote controller at the signal receiving part of the indoor unit. When the signal receiving part has correctly received a signal, it emits a “pi” sound.
- Do not put the remote controller behind a curtain or the like.

# 10 ADDRESS

When two or more indoor units controlled by the same wireless remote controller are installed in a room, a unique address can be set for each indoor unit to prevent interference.

Up to 6 indoor units can be controlled independently by the remote controller by matching the address switch setting of the signal receiving part with the address displayed on the remote controller. The signal receiving part (inside the ceiling panel or indoor unit) has address switches for receiving addresses, and the remote controller has an address button for transmitting addresses.

For details, contact the dealer from whom you purchased the air conditioner.

## ■ Checking Addresses

Push **[ADR]** on the remote controller. The current address appears on the display. When this address equals the address of the address switch in the signal receiving part (inside the ceiling panel or indoor unit), the buzzer sounds. When the address on the display is "ALL," the buzzer sounds and the remote controller is enabled regardless of the address switch setting in the signal receiving part.

Transmit signals while pointing the remote controller at the signal receiving part of the indoor unit to be controlled.

## ■ Matching Addresses

Address setting on the remote controller

1. Push **[ADR]** for at least 4 seconds. "Address" lights up on the display and the current address flashes.
2. Each time you push **[ADR]**, addresses change cyclically like ALL → 1 → 2 → 3... → 6 → ALL. Select an address that matches the address switch setting in the signal receiving part of the indoor unit to be controlled.
3. Push **[SET]**. The flashing address changes to lighting and is displayed for 5 seconds. When this address equals the address switch setting in the signal receiving part, the buzzer sounds.

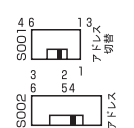
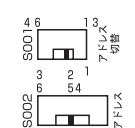
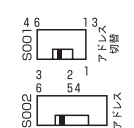
Address displayed on the remote controller (The location of <b>[ADR]</b> is shown on page 3.)	Address <b>ALL</b>	Address <b>1</b>	Address <b>2</b>	-----	Address <b>6</b>
Address switch setting in the signal receiving part (inside the ceiling panel or indoor unit)	* Any setting is OK.			-----	
		Set S001 to the right position (for addresses 1, 2, and 3) or to the left position (for addresses 4, 5, and 6). Set S002 to the right position (for addresses 1 and 4), to the center (for addresses 2 and 5), or to the left position (for addresses 3 and 6).			

# 11 HOW TO PERFORM EMERGENCY OPERATION

In the event of an emergency shown below, push emergency operation on the signal receiving part (inside the ceiling panel or indoor unit) for emergency operation.

- The batteries of the remote controller have been exhausted.
- The remote controller is out of order.
- The remote controller has been lost.

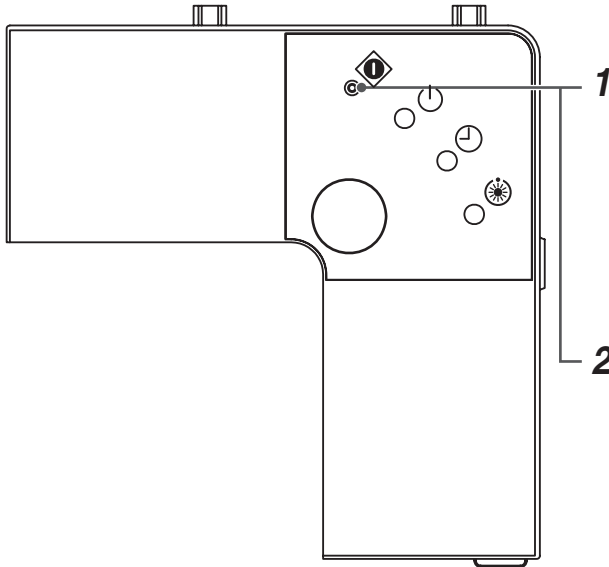

## 1 Start

Push emergency operation.

(When the emergency operation is started at a room temperature of 24°C or more, the air conditioner enters the cooling mode. When the emergency operation is started at a room temperature below 24°C, the air conditioner enters the heating mode.)

## 2 Stop

Push emergency operation once again.







### REQUIREMENT

The test run switch in the signal receiving part is used for a test run during the installation work. Do not use it for other purposes.

# 12 BEFORE ASKING FOR REPAIR WORK

Check the following before asking for repair work.

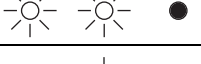
Check again		
Phenomenon	Possible cause	Measures
Operation does not start even if the switch is turned on.	The air conditioner is not working or a power failure has occurred.	Push (⏻) on the remote controller again. (See page 7)
	The power switch is not turned on.	Turn on the power switch if it is off. (See page 7)
	The air conditioner is in the ON timer operation.	Cancel the timer operation. (See page 8)
	The batteries of the remote controller have been exhausted.	Replace the batteries. (See page 10)
	The LEDs on the signal receiving part are not in normal state or operation mode is not correct.	Change the operation mode. (See page 4)
"Auto" or "Heat" is displayed on the display though the air conditioner is cool-only type.	Change the slide switch setting of the remote controller. (See page 10)	
Dual swing, cycle swing, individual louver position, or power-saving cannot be set.	This type of remote controller cannot set such functions.	

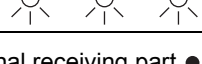
Contact the dealer from whom you purchased the air conditioner.		
Phenomenon	Possible cause	
The LEDs flash.		Communication error between signal receiving part and indoor unit or address setup error when the wired remote controller is used
		Communication error between indoor unit and outdoor unit
		The protective device of the indoor unit is activated.
		The protective device of the outdoor unit is activated.
		Temperature sensor error
		The compressor of the outdoor unit is protected.
		The air conditioner is performing a test run. Set the test run switch to OFF.

LEDs on the signal receiving part ●: OFF ☀: Flashing (at intervals of 0.5 seconds)

LED color ⏻: Green ⏸: Green ☀: Orange

Check these items. If any of these problems still remains, stop the operation, turn off the power, and then notifies the dealer from whom you purchased the air conditioner of the model name and details of the error (including LED flashing state). Never repair any part by yourself as it is dangerous.