

# TOSHIBA

OWNER'S MANUAL  
MANUEL DU PROPRIETAIRE  
BETRIEBSANLEITUNG  
MANUALE DEL PROPRIETARIO  
MANUAL DEL PROPIETARIO  
MANUAL DO UTILIZADOR  
GEBRUIKSAANWIJZING  
ΟΔΗΓΙΕΣ ΧΡΗΣΗΣ

REMOTE CONTROLLER FOR AIR CONDITIONER (SPLIT TYPE)  
TELECOMMANDE POUR CLIMATISEUR (TYPE SPLIT)  
FERNBEDIENUNG FÜR KLIMAGERÄT (SPLIT-SYSTEM)  
TELECOMANDO PER CONDIZIONATORE D'ARIA (TIPO MULTIAMBIENTI)  
CONTROL REMOTO PARA EL APARATO DE AIRE ACONDICIONADO (TIPO SPLIT)  
CONTROLADOR REMOTO PARA AR CONDICIONADO (TIPO SPLIT)  
AFSTANDSBEDIENING VOOR DE AIRCONDITIONER (GESPLITST TYPE)  
ΣΥΣΚΕΥΗ ΤΗΛΕΧΕΙΡΙΣΜΟΥ ΓΙΑ ΚΛΙΜΑΤΙΣΤΙΚΟ (ΤΥΠΟΣ SPLIT)

---

<Wireless Type>  
<Type sans fil>  
<Drahtloses System>  
<Tipo via radio>  
<Modelo inalámbrico>  
<Tipo Sem Fios>  
<Draadloos model>  
<Ασύρματου Τύπου>

## TCB-AX21U (W)-E

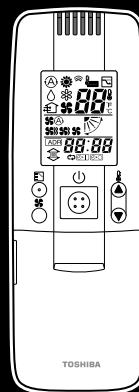

Thank you very much for purchasing TOSHIBA Remote Controller for Air Conditioner.  
Please read this owner's manual carefully before using your Remote Controller for Air Conditioner.

- Be sure to obtain the "Owner's manual" and "Installation manual" from constructor (or dealer).

Request to constructor or dealer  
Please clearly explain the contents of the Owner's manual and hand over it.

---

Nous vous remercions pour avoir choisi une télécommande pour climatiseur TOSHIBA.  
Veuillez lire attentivement ce Manuel du propriétaire avant d'utiliser votre télécommande pour climatiseur.

- Assurez-vous que le constructeur (ou le revendeur) vous remette le "Manuel du propriétaire" et le "Manuel d'installation".

Demande au constructeur ou au revendeur  
Veuillez expliquer clairement le contenu du Manuel du propriétaire et le remettre au client.

---

Wir danken Ihnen, dass Sie sich für eine TOSHIBA Fernbedienung für Klimageräte entschieden haben.  
Bitte lesen Sie diese Bedienungsanleitung sorgfältig, ehe Sie Ihre Fernbedienung für Klimageräte benutzen.

- Lassen Sie sich die "Bedienungsanleitung" und das "Installations-Handbuch" unbedingt vom Installateur oder vom Lieferanten aushändigen.

Eine Bitte an den Installateur oder Lieferanten:  
Bitte erklären Sie dem Käufer den Inhalt der Bedienungsanleitung und händigen sie ihm aus.

---

Grazie di aver acquistato un telecomando TOSHIBA per condizionatore d'aria.  
Prima di usare il telecomando per condizionatore d'aria, leggere con attenzione questo manuale del proprietario.

- Si raccomanda di tenere a portata di mano il "Manuale del proprietario" e il "Manuale di installazione" ricevuti dal produttore (o dal rivenditore).

Richiesta al produttore o al rivenditore  
Spiegare chiaramente il contenuto del Manuale del proprietario e consegnarne una copia all'utente.

---

Muchas gracias por haber adquirido el control remoto TOSHIBA para su aparato de aire acondicionado.  
Lea atentamente este manual del propietario antes de utilizar el control remoto para el aparato de aire acondicionado.

- Asegúrese de que el fabricante (o distribuidor) le proporcione el "Manual del propietario" y el "Manual de instalación".

Solicitud al fabricante o distribuidor  
Explique con claridad el contenido del Manual del propietario y entréguelo al cliente.

---

Agradecemos o facto de ter adquirido o Controlador Remoto para Ar Condicionado da TOSHIBA.  
Lei atentamente o presente Manual do Utilizador antes de utilizar o Controlador Remoto para Ar Condicionado.

- Peça o "Manual do Utilizador" e o "Manual de Instalação" ao fabricante (ou concessionário).

Peça ao fabricante ou representante  
Explique claramente o conteúdo do Manual do Utilizador e proceda à sua entrega.

---

Hartelijk dank voor uw keuze voor een afstandsbediening bij uw airconditioner van TOSHIBA.  
Lees deze gebruiksaanwijzing zorgvuldig door voordat u de afstandsbediening gaat gebruiken.

- Zorg ervoor dat u zowel de 'gebruiksaanwijzing' als de 'installatiehandleiding' van de installateur (of leverancier) krijgt.

Verzoek aan de installateur of de leverancier  
Leg de inhoud van de gebruiksaanwijzing duidelijk uit en overhandig de gebruiksaanwijzing nadien aan de klant.

---

Σας ευχαριστούμε πολύ που προτιμήσατε την TOSHIBA για τη Συσκευή Τηλεχειρισμού για Κλιματιστικό.  
Παρακαλούμε διαβάστε προσεκτικά τις οδηγίες χρήσης πριν από τη χρήση της Συσκευής Τηλεχειρισμού για Κλιματιστικό.

- Φροντίστε να προμηθευτείτε το "Εγχειρίδιο Χρήστη" και το "Εγχειρίδιο Εγκατάστασης" από τον κατασκευαστή (ή τον πωλητή).

Παράκληση για τον κατασκευαστή ή τον πωλητή  
Παρακαλώ εξηγήστε με σαφήνεια τα περιεχόμενα των Οδηγιών Χρήσης και παραδώστε το.

## CONTENTS

PRECAUTIONS FOR SAFETY .....	1	HOW TO INSERT THE BATTERIES .....	10
NAME AND OPERATION .....	2	HOW TO HANDLE THE REMOTE CONTROLLER .....	11
HOW TO SET THE FAN SPEED .....	4	HOW TO USE THE REMOTE CONTROLLER CORRECTLY .....	11
HOW TO OPERATE THE UNIT .....	7	ADDRESS .....	12
HOW TO OPERATE THE TIMER .....	8	HOW TO PERFORM EMERGENCY OPERATION .....	13
HOW TO ADJUST AIR DIRECTION .....	9	BEFORE ASKING REPAIR WORK .....	14
SLIDE SWITCH .....	10		

## SOMMAIRE

MESURES DE SECURITE .....	15	MODE D'INSERTION DES PILES .....	24
NOM ET FONCTIONNEMENT .....	16	MODE DE MANIPULATION DE LA TELECOMMANDE .....	25
MODE DE REGLAGE DE LA VITESSE DE VENTILATION .....	18	MODE D'EMPLOI CORRECT DE LA TELECOMMANDE .....	25
MODE D'EMPLOI DE L'UNITE .....	21	ADRESSE .....	26
MODE D'EMPLOI DE LA MINUTERIE .....	22	MODE D'UTILISATION DU FONCTIONNEMENT DE SECOURS .....	27
MODE DE REGLAGE DU SENS DE DIFFUSION D'AIR .....	23	AVANT TOUTE DEMANDE DE REPARATION .....	28
CURSEUR .....	24		

## INHALT

SICHERHEITSVORKEHRUNGEN .....	29	AUSTAUSCHEN DER BATTERIEN .....	38
BEZEICHNUNGEN UND FUNKTIONEN .....	30	HANDHABUNG DER FERNBEDIENUNG .....	39
EINSTELLUNG DER GEBLÄSEGESCHWINDIGKEIT .....	32	KORREKTE HANDHABUNG DER FERNBEDIENUNG .....	39
BEDIENUNG DES KLIMAGERÄTS .....	35	ADRESS .....	40
BEDIENUNG DER ZEITSCHALTUHR .....	36	NOTBETRIEB .....	41
EINSTELLEN DES LUFTSTROMS .....	37	EHE SIE DEN SERVICE RUFEN .....	42
SCHIEBESCHALTER .....	38		

## INDICE

PRECAUZIONI PER LA SICUREZZA .....	43	COME INSERIRE LE BATTERIE .....	52
NOME E FUNZIONAMENTO .....	44	COME MANEGGIARE IL TELECOMANDO .....	53
COME IMPOSTARE LA VELOCITÀ DELLA VENTOLA .....	46	COME USARE IL TELECOMANDO CORRETTAMENTE .....	53
COME FAR FUNZIONARE L'UNITÀ .....	49	INDIRIZZO .....	54
COME FAR FUNZIONARE IL TIMER .....	50	COME OTTENERE IL FUNZIONAMENTO D'EMERGENZA .....	55
COME REGOLARE LA DIREZIONE DELL'ARIA .....	51	PRIMA DI RICHIERE UN INTERVENTO D'ASSISTENZA O RIPARAZIONE .....	56
INTERRUTTORE A SCORRIMENTO .....	52		

## CONTENIDO

PRECAUCIONES PARA SU SEGURIDAD .....	57	CÓMO COLOCAR LAS PILAS .....	66
NOMBRE Y FUNCIÓN .....	58	CÓMO UTILIZAR EL CONTROL REMOTO .....	67
CÓMO AJUSTAR LA VELOCIDAD DEL VENTILADOR .....	60	CÓMO UTILIZAR CORRECTAMENTE EL CONTROL REMOTO .....	67
CÓMO UTILIZAR LA UNIDAD .....	63	DIRECCIÓN .....	68
CÓMO UTILIZAR EL TEMPORIZADOR .....	64	CÓMO LLEVAR A CABO EL FUNCIONAMIENTO DE EMERGENCIA .....	69
CÓMO AJUSTAR LA DIRECCIÓN DE SALIDA DEL AIRE .....	65	ANTES DE PEDIR REPARACIONES .....	70
CONMUTADOR DESLIZANTE .....	66		

## ÍNDICE

PRECAUÇÕES DE SEGURANÇA .....	71	COMO COLOCAR AS PILHAS .....	80
NOMES E FUNCIONAMENTO .....	72	COMO UTILIZAR O CONTROLADOR REMOTO .....	81
COMO CONFIGURAR A VELOCIDADE DA VENTONHA .....	74	COMO UTILIZAR CORRECTAMENTE O CONTROLADOR REMOTO .....	81
COMO UTILIZAR UNIDADE .....	77	ENDEREÇO .....	82
COMO UTILIZAR O TEMPORIZADOR .....	78	COMO PROCEDER AO FUNCIONAMENTO DE EMERGÊNCIA .....	83
COMO REGULAR A DIRECÇÃO DE AR .....	79	ANTES DE SOLICITAR ASSISTÊNCIA .....	84
INTERRUPTOR DE CORRER .....	80		

## INHOUD

VOORZORGSMATREGELEN VOOR UW VEILIGHEID .....	85	ZO PLAATST U DE BATTERIEN .....	94
NAAM EN FUNCTIE .....	86	ZO BEDIENT U DE AFSTANDSBEDIENING .....	95
ZO STELT U DE VENTILATORSNELHEID IN .....	88	ZO GEBRUIKT U DE AFSTANDSBEDIENING OP DE JUISTE MANIER .....	95
ZO BEDIENT U HET APPARAAT .....	91	ADRES .....	96
ZO BEDIENT U DE TIMER .....	92	ZO GEBRUIKT U DE NOODBEDIENING .....	97
ZO STELT U DE UITBLAASRICHTING VAN DE LUCHT IN .....	93	VOORDAT U EEN ONDERHOUDSMONTEUR INSCHAKELT .....	98
SCHUIFSCHAKELAAR .....	94		

## ΠΕΡΙΕΧΟΜΕΝΑ

ΠΡΟΦΥΛΑΞΕΙΣ ΑΣΦΑΛΕΙΑΣ .....	99	ΤΡΟΠΟΣ ΕΙΣΑΓΩΓΗΣ ΤΩΝ ΜΠΑΤΑΡΙΩΝ .....	108
ΟΝΟΜΑ ΚΑΙ ΛΕΙΤΟΥΡΓΙΑ .....	100	ΤΡΟΠΟΣ ΧΕΙΡΙΣΜΟΥ ΣΥΣΚΕΥΗΣ ΤΗΛΕΧΕΙΡΙΣΜΟΥ .....	109
ΡΥΘΜΙΣΗ ΤΑΧΥΤΗΤΑΣ ΑΝΕΜΙΣΤΗΡΑ .....	102	ΤΡΟΠΟΣ ΣΩΣΤΟΥ ΧΕΙΡΙΣΜΟΥ ΣΥΣΚΕΥΗΣ ΤΗΛΕΧΕΙΡΙΣΜΟΥ .....	109
ΤΡΟΠΟΣ ΛΕΙΤΟΥΡΓΙΑΣ ΜΟΝΟΑΞΟΣ .....	105	ΔΙΕΥΘΥΝΣΗ .....	110
ΤΡΟΠΟΣ ΛΕΙΤΟΥΡΓΙΑΣ ΧΡΟΝΟΔΙΑΚΟΠΤΗ .....	106	ΤΡΟΠΟΣ ΠΡΑΓΜΑΤΟΠΟΙΗΣΗΣ ΕΚΤΑΚΤΗΣ ΛΕΙΤΟΥΡΓΙΑΣ .....	111
ΤΡΟΠΟΣ ΡΥΘΜΙΣΗΣ ΤΗΣ ΔΙΕΥΘΥΝΣΗΣ ΤΟΥ ΑΕΡΑ .....	107	ΠΡΟΤΟΥ ΖΗΤΗΣΕΤΕ ΕΠΙΣΚΕΥΗ .....	112
ΣΥΝΘΕΤΟΣ ΔΙΑΚΟΠΤΗΣ .....	108		

# PRECAUTIONS FOR SAFETY

## WARNING

### WARNINGS ABOUT INSTALLATION

- Make sure to ask the qualified installation professional in electric work to install the remote controller. If the remote controller is inappropriately installed by yourself, it may cause, electric shock, fire, and so on.



### WARNINGS ABOUT OPERATION

- When you are aware of something abnormal with the air conditioner (smells like something etc.), immediately turn off the main power supply switch or circuit breaker, from the mains to stop the air conditioner, and make contact with the dealer. If the air conditioner is continuously operated with something abnormal, it may cause machine failure, electric shock, fire, and so on.



### WARNINGS ABOUT MOVEMENT AND REPAIR

- Do not repair any unit by yourself.
- Whenever the air conditioner needs repair, make sure to ask the dealer to do it. If it is repaired imperfectly, it may cause electric shock or fire.

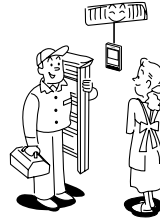

## CAUTION

### CAUTIONS ABOUT OPERATION

- Carefully read this manual before starting the air conditioner. There are many important things for the safety and the correct usage.
- Do not touch any switches with wet finger, otherwise you may get an electric shock.
- When the air conditioner was not be used for a considerably long time, turn off the main switch or the circuit breaker, for safety. Disconnect from the power supply prevents the unit from lightning and power supply surge.
- Prevent any liquid from falling into the remote controller. Do not spill juice, water or any kind of liquid.



# NAME AND OPERATION

## Remote Controller

- Max. 8 indoor units can be operated by a remote controller as a group. (See 12 page.)

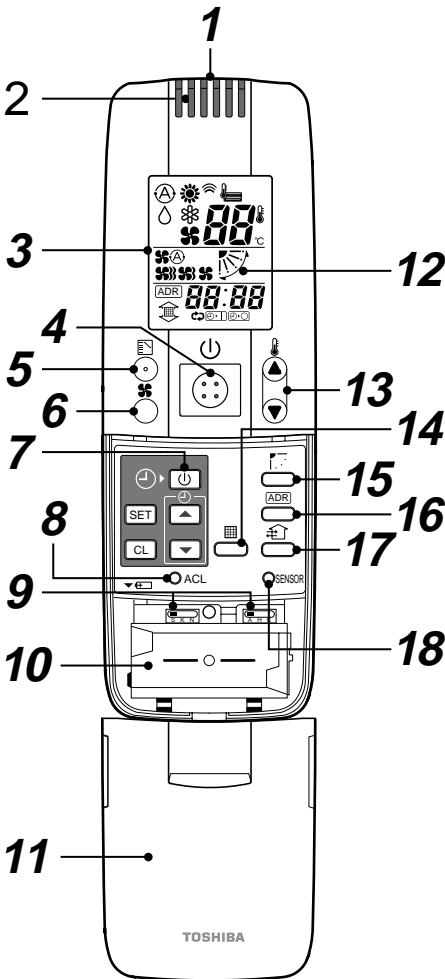

- 1 Transmitting part**
- 2 Remote controller sensor**  
The peripheral temperature is sensed when the sensor button is pushed to remote controller side.
- 3 Mode display section**  
The operation mode is displayed.
- 4 Start/Stop button**  
Pushing this button starts, and pushing again stops the unit.
- 5 Mode Select button**  
Pushing this button selects an operation mode.
- 6 Air volume button**
- 7 Time Setup button**  
This button is used when the timer is setup.
- 8 Reset button**  
This button is used after replacement of battery or selection of slide switch.
- 9 Slide switch**  
(See 10 page.)
- 10 Part storing batteries**  
(See 10 page.)
- 11 Cover**  
Slide the cover holding its both sides.
- 12 AUTO flap display differs according to the installed unit.** (See 9 page.)
- 13 Setup Temp. button**  
Every pushing this button, temperature rises by 1°C.  
Every pushing this button, temperature lowers by 1°C.
- 14 Filter button**  
The remote controller is not operated even if this switch is pushed.
- 15 Swing/Air direction button**  
(See 9 page.)
- 16 Address button**  
(See 12 page.)
- 17 Ventilation button**  
The remote controller is not operated even if this switch is pushed.
- 18 Sensor button**  
This button is used when selecting the temp. sensor at the remote controller side. At the shipment from the factory, this button is set to the temp. sensor at the indoor unit.

- The signal receiving part is mounted to the ceiling panel.

### Signal Receiving Part

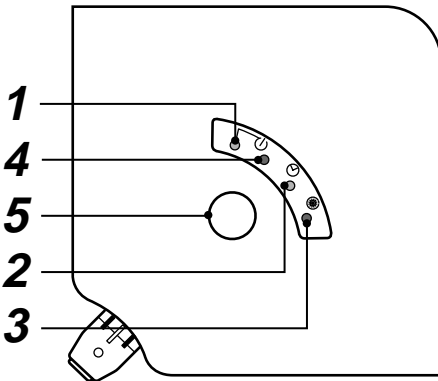

#### 1 Emergency operation button

(See 13 page.)

#### 2 Signal receiving part

The signal sent from the remote controller is received.

#### 3 Display lamp

One of displays flashed while a trouble occurs. When the display lamp flashes, refer to "Before asking of repair" in 14 page.

#### 4 lamp

This lamp goes on during operation.

#### 5 lamp

This lamp goes on while the timer is reserved.

#### 6 lamp

- In heating operation this lamp in the following cases;
  - The operation has started.
  - The temp. controller has worked.
  - The unit is under defrost operation.
- This lamp flashes while a trouble occurs.

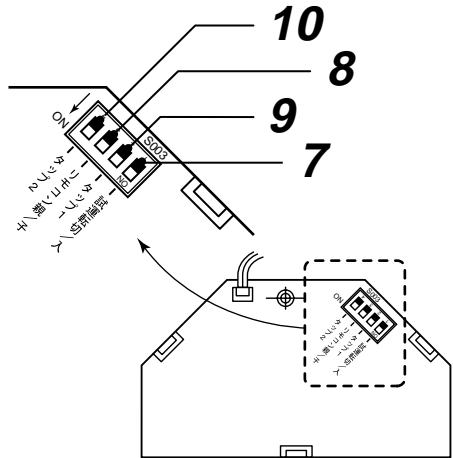

#### 7 試運転入 (S003-1) Trial ON switch

This switch is not used in normal time, but used in trial operation time.

#### 8 リモコン親 / リモコン子 (S003-3) Priority/ Secondary switch

Use this switch at the position of [リモコン親 (PRIORITY)]. This switch can be used together with the wired remote controller.

#### 9 Fan speed change tap 1 (S003-2)

#### 10 Fan speed change tap 2 (S003-4)

These switches are used to select DC motor speed of a 4-way cassette type indoor unit by the taps.



When installing an indoor unit to a high ceiling surface or when changing the number of discharge ports, perform setting referring to the next page.

#### 11 Address switch

(See 12 page.)

This switch distinguishes the signal, send or receive.

The following switches are provided to the rear side of the receiving part. For setup, contact the shop which you purchased the unit.

- If "pi, pi" sound is heard, the MODE lamp of the display lamp goes on, and the  lamp and  lamp flash alternately, the operation is not performed with the desired mode.

# HOW TO SET THE FAN SPEED

When installing a 4-way cassette type indoor unit to high ceiling of a room, the fan motor speed can be selected in agreement with height of the ceiling and numbers of the discharge port. For details, refer to the Installation Manual for 4-way discharge cassette type unit.

Setup No.	Tap 1	Tap 2	Installable ceiling height (Unit: m)								
			RAV-SM560UT-E			RAV-SM800UT-E			RAV-SM1120UT-E RAV-SM1400UT-E		
			4-ways	3-ways	2-ways	4-ways	3-ways	2-ways	4-ways	3-ways	2-ways
(0)	OFF	OFF	2.8	3.2	3.5	3.0	3.3	3.6	3.6	3.9	4.2
	Setting at shipment										
(1)	OFF	ON	3.2	3.5	3.8	3.3	3.5	3.8	3.9	4.1	4.3
(3)	ON	OFF	3.5	3.8	—	3.6	3.8	—	4.2	4.3	—

The fan motor speed is selected by Dip switch [S003] on the sensor P.C. board inside or the adjust corner cap (including sensors) of the ceiling panel of 4-way discharge cassette type indoor unit.

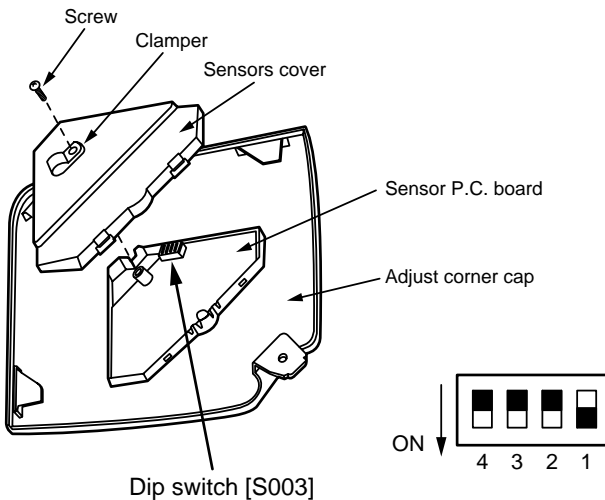

1	Used in [Trial operation]
2	Tap 1 ←
3	Used by selecting [Priority/Secondary]
4	Tap 2 ←

- After selecting a fan motor speed, reassemble the ceiling panel as before. Using a clamper, fix the cable connectors with screws.

## Display Section

All indicators are shown in the right and the lower figures for the explanation.

Only selected contents are display in actual operation.

- When turning on the leakage breaker at the first time 3 minutes later, [SET DATA] flashes about for 1 minute on the display part of the remote controller. While this display is flashing, the model is being automatically confirmed. Accordingly, wait for 1 minute after [SET DATA] display has disappeared, and then use the remote controller.

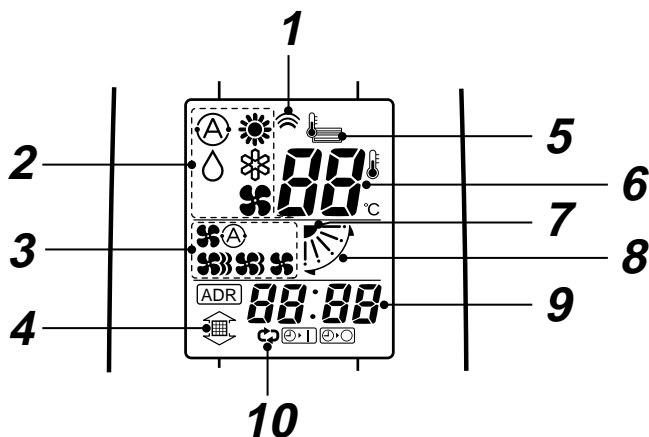
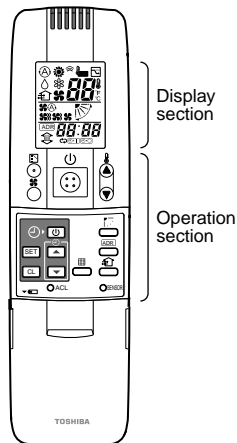

### 1 Transmitting indication

Displayed while operating the switches of the remote controller.

### 2 Mode display

The selected operation mode is displayed.

### 3 Fan mode select display

The selected fan mode is displayed.

(AUTO)

(HIGH)

(MED.)

(LOW)

### 4 Filter display

If "FILTER " is displayed, clean the air filter.

### 5 CHECK display

Displayed while the protective device works or a trouble occurs.

### 6 Set up temperature display

The selected set up temp. is displayed.

### 7 Flap position display

### 8 SWING display

Displayed during up/down movement of the flap.

### 9 Timer time display

Time of the timer is displayed.  
(When a trouble occurs, the check code is displayed.)

### 10 Timer SETIN setup display

When pushing the Timer SET button, the display of the timer is selected in order of [OFF] → [OFF] repeat OFF timer → [ON] → No display.



## Operation Section

Push each button to select a desired operation.

- The details of the operation needs to be set up once, afterward, the air conditioner can be used by pushing (⏻) button only.

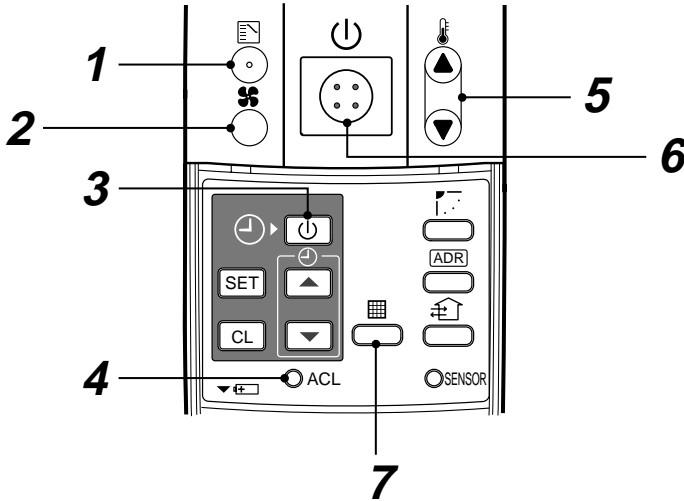

### 1 Operation select button

Selects desired operation mode.

### 2 Fan mode select button

Selects a fan mode.

### 3 Timer set button

TIMER SET button is used when the timer is set up.

### 4 Check button

CHECK button is used for check operation. During normal operation, do not use this button.

### 5 Temperature set button

Adjusts required room temperature. Set required set temperature by pushing (▲) or (▼) .

### 6 Start/Stop button

When the button is pushed, operation starts, and it stops by pushing the button again. When the operation stops, the operation lamp and all displays disappear.

### 7 Filter reset button

Resets (Erases) "FILTER  " display.

### OPTION :

#### Remote controller sensor

Usually the TEMP. sensor of the indoor unit measured a temperature. A temperature around the remote controller can also be measured.

For details, contact the dealer from which you have purchased the air conditioner.

# HOW TO OPERATE THE UNIT

## Cool/Heat AUTO, Heat, Dry, Cool, Fan



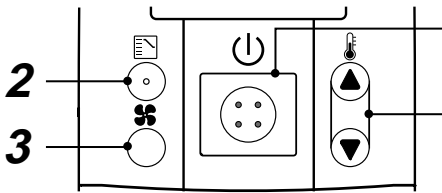

### Power supply

Turn on the power of the wireless remote controller 12 hours before starting the operation.

- After the power supply has been turned on, the operation of the remote controller is not accepted for approx. 1 minute. It is not a failure.  
(The sensor receives the signal once, but the received contents are cleared.)



**1** Push Start/Stop button.

**2** Push  (Operation Select button) operation to select one of , , , and .

**3** Push  (Fan Mode Select button) to select one of fan speed modes.

When selecting , the fan speed is automatically changed.

(During FAN mode, the air speed is not automatically changed.)

**4** Push either  or  to select the desired temperature.

- During FAN mode, the temperature cannot be set up.

### 5 Stop

Push Start/Stop button.

When using the remote controller to stop the unit, the outdoor unit fan may keep operating for a while even if the compressor of the outdoor unit has stopped.

- In heating operation, if the room is not comfortably heated with FAN , select FAN  or .

Although they are displayed, the function may not be provided according to the used indoor unit. (Fan speed is constant.)

- When the unit cannot be stopped by the normal operation

Turn off the power switch or leakage breaker, and then contact the shop which you purchased the unit.

## Automatic cool/heat

When all indoor units in the identical refrigerant system are controlled as a group, the cooling/heating operation is automatically performed with the difference between the setup temperature and the room temperature.

## Dry operation

- There is no dry function according to the used indoor unit even if DRY is displayed on the display section of the remote controller. (Same to Cooling operation)
- When the room temperature approaches the setup temperature, running/stop operations are automatically repeated.
- In order not to return humidity to the room as possible, the mode of indoor fan enters LOW mode when the operation has stopped.
- The fan speed cannot be adjusted according to the used indoor unit or status of the room temperature.
- The DRY mode cannot be used according to the used indoor unit when the outdoor temperature is 15°C or lower.

# HOW TO OPERATE THE TIMER

- After setting of the timer, set the remote controller at a position where the signal can reach the sensors (indoor unit body).  
(The signal of the timer operation is sent from the remote controller.)
- Set up the timer during display of the operation mode.

Use in the following cases	During display
To stop the air conditioner after the previously set time has passed	
To stop the air conditioner every time after the previously set time has passed	
To operate the air conditioner after the previously set time has passed	

## Timer time

Every pushing , the setup time increases by 0.5 hour (30 minutes).  
The maximum time to be set is 72.0 hours.

Every pushing , the setup time decreases by 0.5 hour (30 minutes).  
The minimum time to be set is 0.5 hours.

## Timer display

Every pushing , the display changes as follows;

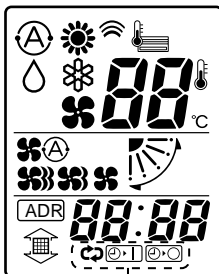

No display



## <Use example>

### How to use OFF timer

(Ex.) To stop the unit 30 minutes after

- 1 When pushing the timer once, and the time flash on the remote controller.
- 2 Push TIME or to set the time to 0.5.
- 3 Push and the go on timer.

### How to use the repeat timer

(Ex.) To stop the air conditioner every time after 2.5 hours has passed

- 1 When pushing the timer twice, , and the time flash on the remote controller.
- 2 Push TIME or to set the time to 2.5.
- 3 Push and the , go on timer.

The works, and the operation stops after 2.5 hours. When pushing (Start/Stop) button again to operate the unit, the operation stops after 2.5 hours.

### How to use ON timer

(Ex.) To operate the unit 8 hours after

- 1 When pushing the timer three times, and the timer flash on the remote controller.
- 2 Push TIME or to set the time to 8.0.
- 3 Push 

The operation mode display disappears, and then time and the go on.

### To stop the timer operation

To stop the timer operation  
Push button. Then the timer display disappears.



# HOW TO ADJUST AIR DIRECTION

- Never move the flap (Air direction up/down adjusting plate) which is operated on the remote controller with hands except a case of cleaning of the flap.
- While the unit stops, the flap (Air direction up/down adjusting plate) directs downward automatically.
- During preparation of heating, the flap (Air direction up/down adjusting plate) directs upward. The swinging operation starts after heating preparation status has been cleared. However, swinging is displayed on the AUTO flap display of the remote controller even if the heating operation is being prepared.



## How to set up the air direction

Every pushing  button during operation, the air direction changes.

## How to start swinging

When pushing  button, set the direction of the flap (Air direction up/down adjusting plate) to the lowest position, and then push  button again, the swinging is displayed and the air direction automatically changes upward/downward.

## How to stop swinging

Pushing  button once again during swinging of the flap stops the flap at the desired position. Then, when pushing  button, the air direction can be set to position from the uppermost position.

- In cooling or dry operation, the flap does not stop when the flap directs downward. If doing so, the flap stops at the 3<sup>rd</sup> position from the uppermost position.

### In heating operation

Direct the flap (Air direction up/down adjusting plate) downward, otherwise the hot air may not reach at the foot.

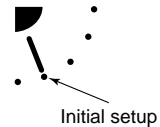

### In cooling/dry operation

Direct the flap (Air direction up/down adjusting plate) upward, otherwise dewdrops may adhere or drip down to near of the discharge grille.

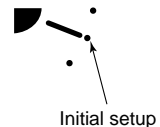

### In air blowing operation

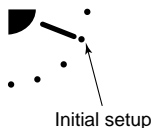

### In all operation modes



### Display when swinging stopped



## SLIDE SWITCH

- Do not change setting of the slide switch because a malfunction occurs by other settings.
- Before usage, check the slide switch is set to the position as follows;

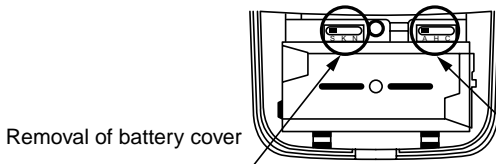

Removal of battery cover

	Corresponding model for change of flap
Slide switch position	
Flashing position on remote controller	HIGH MED.  Swing

Operation mode display of remote controller
Slide switch position

## HOW TO INSERT THE BATTERIES

1. Holding the both sides of the cover and remove it by sliding downward.
  2. Correctly insert 2 AAA alkali batteries matching + and - polarities with indications.
  3. Push RESET button with something tipped and attach the cover.
- Replace the batteries when the display section of the remote controller is difficult to be read, or when the signal cannot be sent if you are not close to the sensor.  
(The standard replacement time of the alkali batteries is approx. one year.)
  - Use the same type of new batteries for replacing two batteries.
  - In case when you do not the remote controller for a long time, remove the batteries.

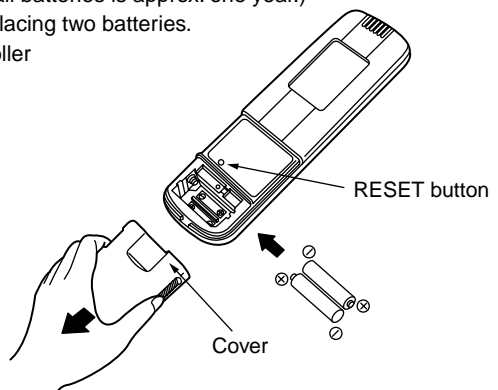

## HOW TO HANDLE THE REMOTE CONTROLLER

- Direct the transmitter of the remote controller toward the sensor (indoor unit body). When the signal is normally received, "Pi" sound is heard once. ("Pi, pi" sounds are heard only when the operation has started.)
- The standard distance which the signal can be received is approx. 7m. The distance differs a little according to the capacity of the battery, etc.
- Be careful there is not something to block the signal between the sensor (indoor unit body) and the remote controller.
- Do not put the remote controller on the place exposed to the direct sunlight or air from the air conditioner or near the stove, etc.
- Do not drop, throw, or clean with water the remote controller.
- The signal may be accepted in a room where the electronic instantaneous-ON type or inverter type florescent light is set. For details, contact the shop which you purchased the air conditioner.

### To Use the Remote Controller Setting to Wall, etc.

- Check a signal is received correctly by pushing (⏻) Start/Stop button at the position to be fixed.
- To take off remote controller, pull it toward you.

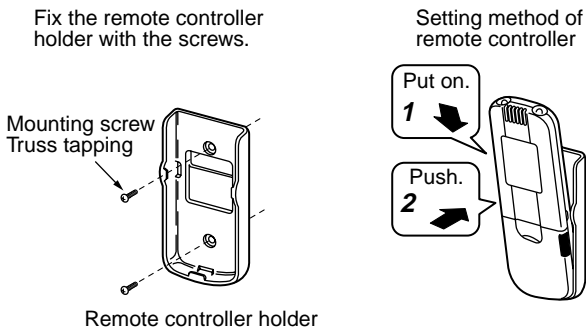

## HOW TO USE THE REMOTE CONTROLLER CORRECTLY

- **Set the remote controller so that it is not excessively far from the sensor (indoor unit), otherwise a malfunction is caused.**  
Be sure to set the remote controller in the same room where the sensor (indoor unit) is installed.
- **Direct the remote controller toward the sensor (indoor unit) for operation.**  
When a signal is correctly received, "Pi" sound can be heard.
- **Avoid to set the remote controller at a place where it is covered with curtain, etc.**

# ADDRESS

When the multiple indoor units corresponding to the wireless remote controller are installed in the same room, an address can be set up to prevent an interference.

Matching the address switch of the sensor with number of the remote controller address, Max. 6 indoor units can be controlled by the corresponding remote controller individually.

The address switch for receiving the signal is prepared to the sensor (inside of panel or indoor unit) and the address switch for sending the signal is prepared to the remote controller. For details, contact the shop which you purchased the air conditioner.

## How to Check the Address

When pushing **[ADR]** button on the remote controller, the present address is displayed on the display section of the remote controller. If this address matches with the address of the sensor (inside of panel or indoor unit), a buzzer sounds.

(When ALL is displayed, buzzer sound is necessarily heard.)

When ALL is displayed, the air conditioner can be operated regardless of any address of the sensor (inside of the indoor unit). Send the signal by directing the remote controller toward the sensor (panel or indoor unit body) to be handled.

## How to Match the Address

Setup to remote controller address

- When keeping **[ADR]** pushed for 4 seconds or more, **[ADR]** lamp goes on at the display section of the remote controller and the present address is displayed with flashing.
- Every pushing **[ADR]**, the address is exchanged as ALL → 1 → 2 → 3 ... → 6 → ALL. Match one of them with the address switch of the indoor unit sensor to be handled.
- When pushing **[CL]**, the address display goes on and is displayed for 5 seconds. If the address matches with the address switch of the operation part, the buzzer sounds.

Display of remote controller address	Address <i>ALL</i>	Address <i>1</i>	Address <i>2</i>	.....	Address <i>6</i>
Address switch position of sensor	* Address switch of sensor unit can be set any position.			.....	

Turn the knob to the right side for 1 to 3 while to the left side for 4 to 6 of Address select switch S001.

## HOW TO PERFORM EMERGENCY OPERATION

In the following cases, operate the air conditioner in emergency by emergency operation of the operation part (inside of panel or indoor unit).

- The battery in the remote controller expired.
- A trouble occurred on the remote controller.
- The remote controller have disappeared.

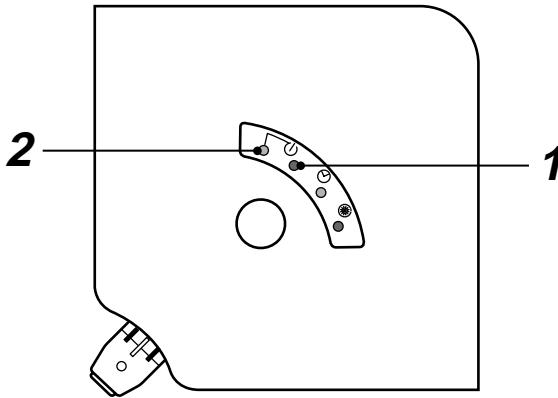

### 1 Start

Push emergency operation.

(If starting the operation when the room temperature is 24°C or higher, the mode enters COOL mode. If starting the operation when the room temperature is 24°C or lower, the mode enters HEAT mode.)

### 2 Stop

Push emergency operation once more.

### CAUTION







- The ON switch of the test run and the ON switch of the test are used for the test run mode in the installation time. Do not use them in the normal time.
- If the “all stop” is selected in the normal/all stop switches, a signal from the remote controller is not accepted.



# BEFORE ASKING REPAIR WORK

Before asking a repair work, check the following items.

Phenomenon		Cause	Measures
Check again	Operation does not start even if the switch is turned on.	Stopped? or after power failure?	Push Start/Stop of the remote controller.
		Is the power supply of the power switch?	Turn on the power supply switch if not.
		Fuse?	Contact the shop which you purchased the air conditioner.
		Is not the mode ON timer?	Delete the timer operation.
		Is not [ALL OFF] of [Signal Receiving Part] selected?	Set the switch to [Normal position], and stop the operation.
		Is not the battery of the remote controller expired?	Replace the battery.
		Is not the state of the display lamp "Disagreement of ❄️ (cool) and ☀️ (heat)" or "No (A)"?	Change the operation mode.

Phenomenon	Cause	
Contact the shop which you purchased the air conditioner	<Display lamp flashes.> 	<ul style="list-style-type: none"> <li>It is a communication error between the sensor and the indoor unit, or setup error of the address when the wired remote controller is used.</li> </ul>
		<ul style="list-style-type: none"> <li>A communication error between the indoor unit and the outdoor unit.</li> </ul>
		<ul style="list-style-type: none"> <li>A protective device of the indoor unit works.</li> </ul>
		<ul style="list-style-type: none"> <li>A protective device of the outdoor unit works.</li> </ul>
		<ul style="list-style-type: none"> <li>A trouble occurred on the temperature sensor.</li> </ul>
		<ul style="list-style-type: none"> <li>The compressor of the outdoor unit is protected.</li> </ul>
		<ul style="list-style-type: none"> <li>The test run is performed. Turn off the Trial ON switch.</li> </ul>

Please check the above items. If the trouble yet remains, stop the operation, turn off the power switch, and then notify the shop which you purchased the air conditioner of the part No. and phenomenon. Never repair any part by yourself because it is very dangerous. If the display lamp is flashing, also tell of its contents.