

TOSHIBA

OWNER'S MANUAL
MANUEL DU PROPRIETAIRE
BETRIEBSANLEITUNG
MANUALE DEL PROPRIETARIO
MANUAL DEL PROPIETARIO
MANUAL DO UTILIZADOR
GEBRUIKSAANWIJZING
ΟΔΗΓΙΕΣ ΧΡΗΣΗΣ

AIR CONDITIONER (SPLIT TYPE)
CLIMATISEUR (TYPE SPLIT)
KLIMAGERÄT (SPLIT-TYP)
CONDIZIONATORE D'ARIA (TIPO SPLIT)
AIRE ACONDICIONADO (TIPO SPLIT)
AR CONDICIONADO (TIPO SPLIT)
AIRCONDITIONER (GESPLITST TYPE)
ΚΛΙΜΑΤΙΣΤΙΚΟ (ΔΙΑΙΡΟΥΜΕΝΟΥ ΤΥΠΟΥ)

<Concealed Duct Type>/<Type à conduits dissimulés>
<Lüftungskanalmontage in der Zwischendecke>/<Tipo a condotto nascosto>
<Modelo con conductos ocultos>/<Tipo condotta embutida>
<Type met weggewerkte kanalen>/<Τύπος συγκεκαλυμμένου αγωγού>

Heat Pump Model/Modèle à thermopompe
Geräte mit Heizung/Modello con pompa di riscaldamento
Modelo con bomba de calor/Modelo de bomba térmica
Model met warmtepomp/Μοντέλο με Αντλία Θερμότητας



Indoor Unit/Unité intérieure
Raumeinheit/Unità interna
Unidad interior/Unidade interior
Binnenunit/Εσωτερική Μονάδα

Outdoor Unit/Unité extérieure
Außengerät/Unità esterna
Unidad exterior/Unidade exterior
Buitenunit/Εξωτερική Μονάδα

RAV-SM562BT-E
RAV-SM802BT-E
RAV-SM1102BT-E
RAV-SM1402BT-E

RAV-SM562AT-E SP562AT-E
RAV-SM802AT-E SP802AT-E
RAV-SM1102AT-E SP1102AT-E
RAV-SM1402AT-E SP1402AT-E

Thank you very much for purchasing TOSHIBA Air Conditioner.

Please read this owner's manual carefully before using your Air Conditioner.

• Be sure to obtain the "Owner's manual" and "Installation manual" from constructor (or dealer).

Request to constructor or dealer

• Please clearly explain the contents of the Owner's manual and hand over it.

Nous vous remercions pour avoir choisi un climatiseur TOSHIBA.

Veuillez lire attentivement ce Manuel du propriétaire avant d'utiliser votre climatiseur.

• Assurez-vous que le constructeur (ou le revendeur) vous remette le "Manuel du propriétaire" et le "Manuel d'installation".

Demande au constructeur ou au revendeur

• Veuillez expliquer clairement le contenu du Manuel du propriétaire et le remettre au client.

Wir danken Ihnen, dass Sie sich für ein TOSHIBA Klimagerät entschieden haben.

Bitte lesen Sie diese Betriebsanleitung, bevor Sie Ihr Klimagerät benutzen, sorgfältig.

• Lassen Sie sich die "Betriebsanleitung" und das "Installations-Handbuch" unbedingt vom Installateur oder vom Lieferanten aushändigen.

Eine Bitte an den Installateur oder Lieferanten:

• Bitte erklären Sie dem Käufer den Inhalt der Betriebsanleitung und händigen sie ihm aus.

Grazie di aver acquistato un condizionatore d'aria TOSHIBA.

Prima di usare il condizionatore d'aria, leggere con attenzione questo manuale del proprietario.

• Si raccomanda di tenere a portata di mano il "Manuale del proprietario" e il "Manuale di installazione" ricevuti dal produttore (o dal rivenditore).

Richiesta al produttore o al rivenditore

• Spiegare chiaramente il contenuto del Manuale del proprietario e consegnarne una copia all'utente.

Muchas gracias por haber adquirido el aparato de aire acondicionado TOSHIBA.

Lea atentamente este manual del propietario antes de utilizar el aparato de aire acondicionado.

• Asegúrese de que el fabricante (o distribuidor) le proporcione el "Manual del propietario" y el "Manual de instalación".

Solicitud al fabricante o distribuidor

• Explique con claridad el contenido del Manual del propietario y entréguelo al cliente.

Muito obrigada por adquirir o Ar Condicionado TOSHIBA.

Leia atentamente este manual do utilizador antes de utilizar o seu ar condicionado.

• Não se esqueça de receber o "Manual do utilizador" e o "Manual de instalação" do fabricante (ou agente).

Pedido ao fabricante ou agente

• Explique por favor o conteúdo do Manual do utilizador e entregue-o.

Hartelijk dank voor uw keuze voor een airconditioner van TOSHIBA.

Lees deze gebruiksaanwijzing zorgvuldig door voordat u de airconditioner gaat gebruiken.

• Zorg ervoor dat u zowel de 'gebruiksaanwijzing' als de 'installatiehandleiding' van de installateur (of leverancier) krijgt.

Verzoek aan de installateur of de leverancier

• Leg de inhoud van de gebruiksaanwijzing duidelijk uit en overhandig de gebruiksaanwijzing nadien aan de klant.

Σας ευχαριστούμε πολύ που προτιμήσατε για την αγορά σας ένα Κλιματιστικό TOSHIBA.

Παρακαλούμε διαβάστε προσεκτικά τις οδηγίες χρήσης πριν από τη χρήση του Κλιματιστικού.

• Βεβαιωθείτε ότι ο κατασκευαστής (ή ο πωλητής) σας παρέδωσε και τις "Οδηγίες Χρήσης" και το "Εγχειρίδιο Εγκατάστασης".

Παράκληση για τον κατασκευαστή ή τον πωλητή

• Παρακαλώ εξηγήστε με σαφήνεια τα περιεχόμενα των Οδηγιών Χρήσης και παραδώστε το.

ADOPTION OF NEW REFRIGERANT

This Air Conditioner is a new type which adopts a new refrigerant HFC (R410A) instead of the conventional refrigerant R22 in order to prevent destruction of the ozone layer.

UTILISATION DU NOUVEAU REFRIGERANT

Ce climatiseur est d'un type inédit qui utilise le nouveau réfrigérant HFC (R410A) au lieu du réfrigérant traditionnel R22, afin d'éviter la destruction de la couche d'ozone.

EINFÜHRUNG EINES NEUEN KÜHLMITTELS

Dies ist ein neuartiges Klimagerät. Anstatt des herkömmlichen Kühlmittels R22 verwendet es das neue ozonschichtschonende HFC Kühlmittel R410A.

ADOZIONE DI UN NUOVO REFRIGERANTE

Questo condizionatore d'aria è di un tipo nuovo che adotta un nuovo refrigerante HFC (R410A) al posto del refrigerante convenzionale R22, per prevenire la distruzione dello strato di ozono dell'atmosfera terrestre.

ADOPCIÓN DE NUEVO REFRIGERANTE

Este aparato de aire acondicionado es un modelo reciente que incorpora el nuevo refrigerante HFC (R410A) en lugar del refrigerante convencional R22 para así evitar daños en la capa de ozono.

ADOPÇÃO DO NOVO REFRIGERANTE

Este ar condicionado é um modelo novo que adota um novo refrigerante HFC (R410A) em vez do refrigerante convencional R22 para evitar a destruição da camada de ozono.

TOEPASSING VAN EEN NIEUW KOELMIDDEL

Deze airconditioner is een nieuwe type dat werkt met een nieuw koelmiddel HFC (R410A) in plaats van met het conventionele koelmiddel R22, als bijdrage om de aantasting van de ozonlaag te reduceren.

ΥΙΟΘΕΤΗΣΗ ΝΕΟΥ ΨΥΚΤΙΚΟΥ

Το παρόν Κλιματιστικό είναι νέος τύπος που υιοθετεί νέο ψυκτικό HFC (R410A) στη θέση του συμβατικού ψυκτικού R22 προκειμένου να βοηθήσει στην προστασία του όζοντος.

CONTENTS

ACCESSORIES (SOLD SEPARATELY)	1	TIMER OPERATION	8
PRECAUTIONS FOR SAFETY	1	MAINTENANCE	10
PARTS NAME	3	AIR CONDITIONER OPERATIONS AND PERFORMANCE	11
PARTS NAME OF REMOTE CONTROLLER	4	RE-INSTALLATION	12
CORRECT USAGE	6	TROUBLES AND CAUSES	12
AUTOMATIC OPERATION (Auto Changeover)	7	TROUBLES AND CAUSES (Concerning Remote Controller) ..	14

SOMMAIRE

ACCESSOIRES (VENDUS SEPARÉMENT)	15	FONCTIONNEMENT PAR MINUTERIE	22
MESURES DE SECURITE	15	ENTRETIEN	24
NOM DES PIÉCES	17	FONCTIONNEMENT ET PERFORMANCES DU CLIMATISEUR ..	25
NOM DES PIÉCES DE LA TELECOMMANDE	18	REINSTALLATION	26
UTILISATION CORRECTE	20	PROBLEMES ET CAUSES	26
FONCTIONNEMENT AUTOMATIQUE (Commutation Automatique)	21	PROBLEMES ET CAUSES (Concernant la Télécommande) ...	28

INHALT

ZUBEHÖR (GESONDERT ERHÄLTlich)	29	ZEITBETRIEB	36
SICHERHEITSVORKEHRUNGEN	29	WARTUNG	38
TEILEBEZEICHNUNGEN	31	FUNKTIONEN UND LEISTUNG DES KLIMAGERÄTS	39
TEILEBEZEICHNUNG DER FERNBEDIENUNG	32	NEU-INSTALLATION	40
RICHTIGE HANDHABUNG	34	STÖRUNGEN UND IHRE URSACHEN	40
AUTOMATISCHER BETRIEB (Automatischer Wrcchsel)	35	STÖRUNGEN UND IHRE URSACHEN (Fernbedienung)	42

INDICE

ACCESSORI (DA ACQUISTARE A PARTE)	43	FUNZIONAMENTO CON TIMER	50
PRECAUZIONI PER LA SICUREZZA	43	MANUTENZIONE	52
NOME DELLE PARTI	45	OPERAZIONI E PRESTAZIONI DEL CONDIZIONATORE D'ARIA	53
NOME DELLE PARTI DEL TELECOMANDO	46	RE-INSTALLAZIONE	54
USO CORRETTO	48	PROBLEMI E CAUSE	54
FUNZIONAMENTO AUTOMATICO (Commutazione Automatica)	49	PROBLEMI E CAUSE (Riguardanti il Telecomando)	56

CONTENIDO

ACCESORIOS (VENDIDOS POR SEPARADO)	57	FUNCIÓNAMIENTO DEL TEMPORIZADOR	64
PRECAUCIONES PARA SU SEGURIDAD	57	MANTENIMIENTO	66
NOMBRE DE LOS COMPONENTES	59	FUNCIÓNES Y RENDIMIENTO DEL APARATO DE AIRE ACONDICIONADO	67
DESCRIPCIÓN DE LOS BOTONES DEL CONTROL REMOTO ..	60	REINSTALACIÓN	68
UTILIZACIÓN CORRECTA	62	PROBLEMAS Y CAUSAS	68
FUNCIÓNAMIENTO AUTOMÁTICO (Cambio automático)	63		

ÍNDICE

ACESSÓRIOS (VENDIDO SEPARADAMENTE)	71	OPERAÇÃO DO TEMPORIZADOR	78
PRECAUÇÕES DE SEGURANÇA	71	MANUTENÇÃO	80
NOME DAS PEÇAS	73	OPERAÇÃO E FUNCIONAMENTO DO AR CONDICIONADO ...	81
NOME DAS PEÇAS DO CONTROLADOR REMOTO	74	REINSTALAÇÃO	82
UTILIZAÇÃO CORRECTA	76	PROBLEMAS E CAUSAS	82
FUNCIÓNAMIENTO AUTOMÁTICO (Mudança Automática)	77	PROBLEMAS E CAUSA (Respeitantes ao Controlador Remoto)	84

INHOUD

ACCESSOIRES (NIET MEEGELEVERD)	85	DE TIMER GEBRUIKEN	92
VOORZORGSMAATREGELEN VOOR UW VEILIGHEID	85	ONDERHOUD	94
BENAMING VAN DE ONDERDELEN	87	BEDIENING EN WERKING VAN DE AIRCONDITIONER	95
BENAMING VAN DE ONDERDELEN VAN DE AFSTANDBEDIENING	88	OPNIEUW INSTALLEREN	96
CORRECT GEBRUIK	90	PROBLEMEN EN OORZAKEN	96
AUTOMATISCHE BEDIENING (Automatisch Omschakelen) ...	91	AUTOMATISCHE BEDIENING (Automatisch Omschakelen) ...	98

ΠΕΡΙΕΧΟΜΕΝΑ

ΠΑΡΕΛΚΟΜΕΝΑ (ΠΩΛΟΥΝΤΑΙ ΞΕΧΩΡΙΣΤΑ)	99	ΛΕΙΤΟΥΡΓΙΑ ΧΡΟΝΟΔΙΑΚΟΠΤΗ	106
ΠΡΟΦΥΛΑΞΕΙΣ ΑΣΦΑΛΕΙΑΣ	99	ΣΥΝΤΗΡΗΣΗ	108
ΟΝΟΜΑ ΤΜΗΜΑΤΩΝ	101	ΛΕΙΤΟΥΡΓΙΕΣ ΚΛΙΜΑΤΙΣΤΙΚΟΥ ΚΑΙ ΑΠΟΔΟΣΗ	109
ΟΝΟΜΑΣΙΑ ΤΜΗΜΑΤΩΝ ΤΟΥ ΤΗΛΕΧΕΙΡΙΣΤΗΡΙΟΥ	102	ΕΓΚΑΤΑΣΤΑΣΗ ΕΚ ΝΕΟΥ	110
ΟΡΘΗ ΧΡΗΣΗ	104	ΠΡΟΒΛΗΜΑΤΑ ΚΑΙ ΑΙΤΙΕΣ	110
ΑΥΤΟΜΑΤΗ ΛΕΙΤΟΥΡΓΙΑ (Αυτόματη Μεταβολή)	105	ΠΡΟΒΛΗΜΑΤΑ ΚΑΙ ΑΙΤΙΑ (Σχετικά με το Τηλεχειριστήριο) ..	112

ENGLISH

FRANCAIS

DEUTSCH

ITALIANO

ESPAÑOL

PORTUGUÊS

NEDERLANDS

ΕΛΛΗΝΙΚΑ

ACCESSORIES (SOLD SEPARATELY)

Remote controller

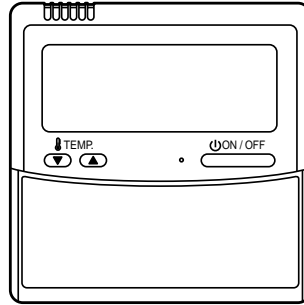

PRECAUTIONS FOR SAFETY

WARNING

WARNINGS ABOUT INSTALLATION

- Make sure to ask the qualified installation professional in electric work to install the air conditioner.
If the air conditioner is inappropriately installed by yourself, it may cause water leak, electric shock, fire, and so on.
- Be sure to provide grounding.
Do not connect ground wires to gas pipes, water pipes, lightning rods or ground wires for telephone cables.



CAUTION

TO DISCONNECT THE APPLIANCE FROM THE MAINS SUPPLY

This appliance must be connected to the mains by means of a switch with a contact separation of at least 3 mm.

The installation fuse (25A D type ) must be used for the power supply line of this conditioner.

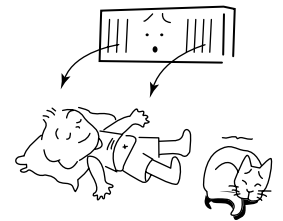

WARNINGS ABOUT OPERATION

- Cleaning of the air filter and other parts of the air filter involves dangerous work in high places, so be sure to have a service person do it. Do not attempt it yourself. The cleaning diagram for the air filter is there for the service person, and not for the customer.
- Avoid cooling the room too strong or exposing the human body to cool breeze for a long time as it is bad for the health.
- When you notice something abnormal with the air conditioner (smells like something scorching, poor cooling, etc.), immediately turn off the main switch, the circuit breaker, from the mains to stop the air conditioner, and contact the dealer. If the air conditioner is continuously operated with something abnormal, it may cause machine failure, electric shock, fire, and so on.

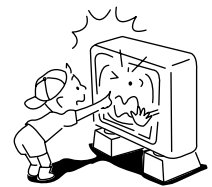

WARNINGS ABOUT MOVEMENT AND REPAIR

- Do not move or repair any unit by yourself.
Since there is high voltage inside the unit, you may get electric shock when removing the cover and main unit.
- Whenever the air conditioner needs repair, make sure to ask the dealer to do it.
If it is repaired imperfectly, it may cause electric shock or fire.
- When moving the air conditioner for re-installing at another place, ask the dealer to do it. If it is imperfectly installed, it may cause electric shock or fire.



CAUTION

CAUTIONS ABOUT INSTALLATION

- Be sure to confirm the following cautions.
- Certainly lay the drain hose for perfect draining. Bad drainage may cause flooding in the house and getting furniture wet.
- Make sure to connect the air conditioner to an exclusive power supply of the rated voltage, otherwise the unit may break down or cause a fire.
- Do not install the unit in a place where inflammable gas may leak. If inflammable gas accumulates around the unit, it may cause a fire.

CAUTIONS ABOUT OPERATION

- Carefully read this manual before starting the air conditioner. There are many important things to keep in mind for daily operation.
- Do not use this air conditioner for special purposes such as preserving food, precision instruments, art objects, breeding animals, growing potted plants, etc.
- Avoid exposing potted plants and animals to the wind of the air conditioner, since it badly affects the health and growth of them.
- When the air conditioner is operated with a combustion appliance in the same place, be careful of ventilation to let fresh air enter the room. Poor ventilation causes oxygen shortage.
- Do not place any combustion appliance in a place where it is directly exposed to the wind of air conditioner, otherwise it may cause imperfect combustion.
- When the air conditioner is used in a closed room, be careful of sufficient ventilation of the room. Poor ventilation causes oxygen shortage.
- Do not touch any switches with wet finger, otherwise you may get an electric shock.
- If the air conditioner won't be used for a considerably long time, turn off the main switch or the circuit breaker, for safety.
- Check the concrete blocks, etc. of the base of the outdoor unit occasionally. If the base is left damaged or deteriorated, the unit may topple over and inflict an injury to a person as the worst case.
- Do not put anything on the outdoor unit nor step onto it. If you do so, it may not only topple over the unit but also injure yourself.
- To make the air conditioner operate in its original performance, operate it within the range of the operating temperature specified in the instructions. Otherwise it may cause a malfunction, or water leak from the unit.
- Prevent any liquid from falling into the remote controller. Do not spill juice, water or any kind of liquid.

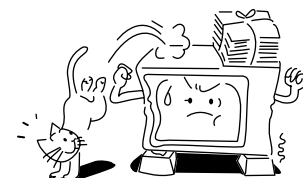
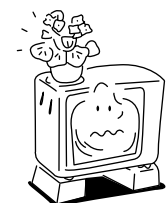
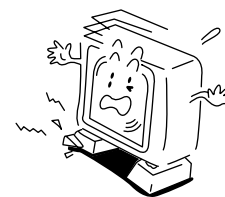
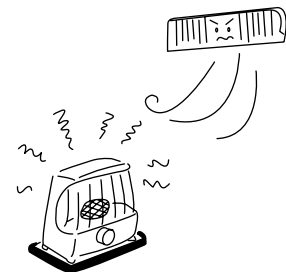
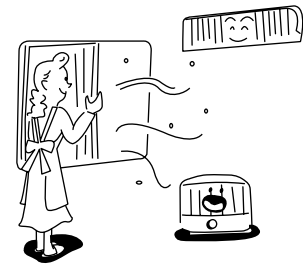
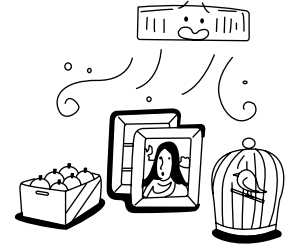
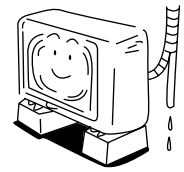

PARTS NAME

Indoor unit

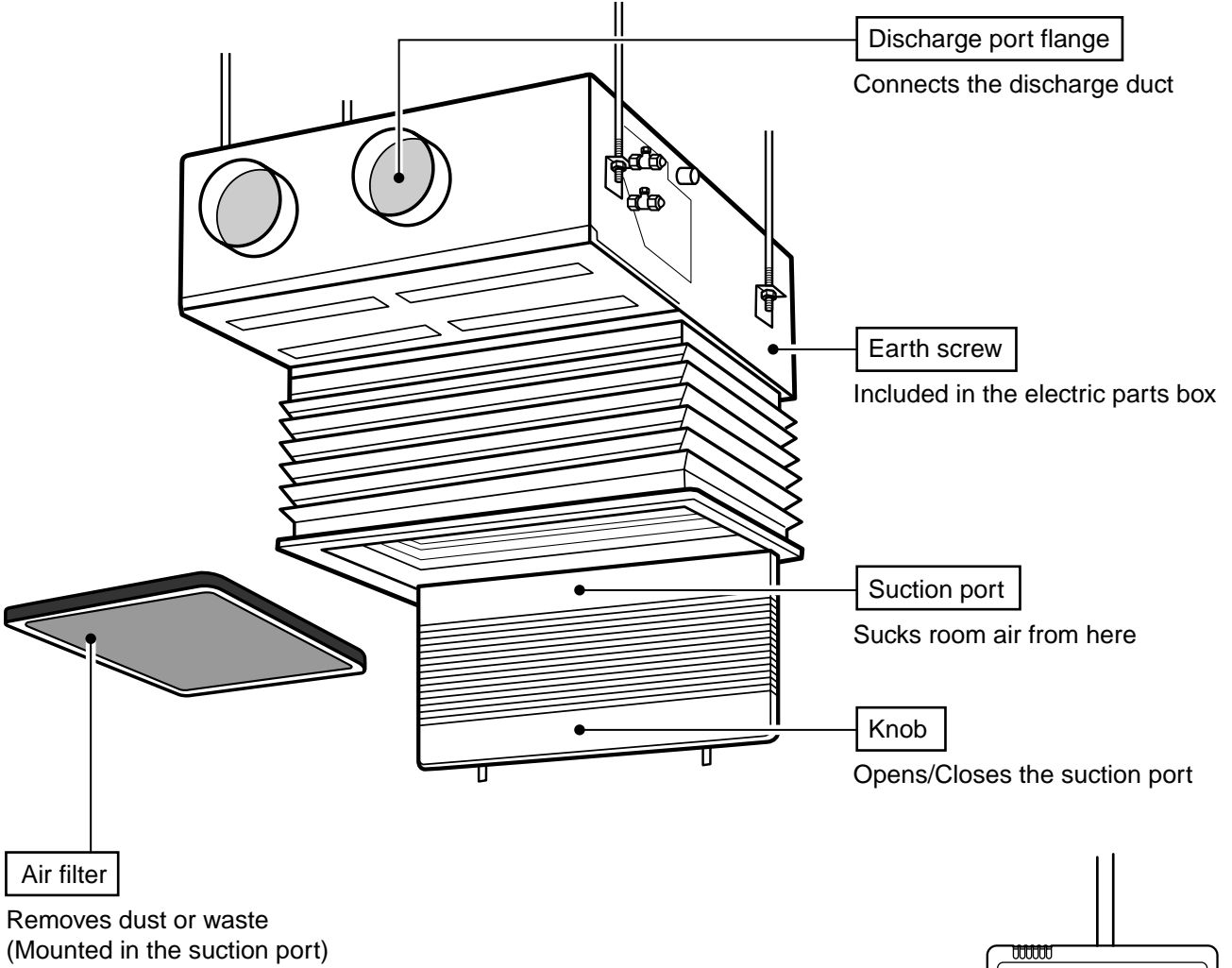

Outdoor unit

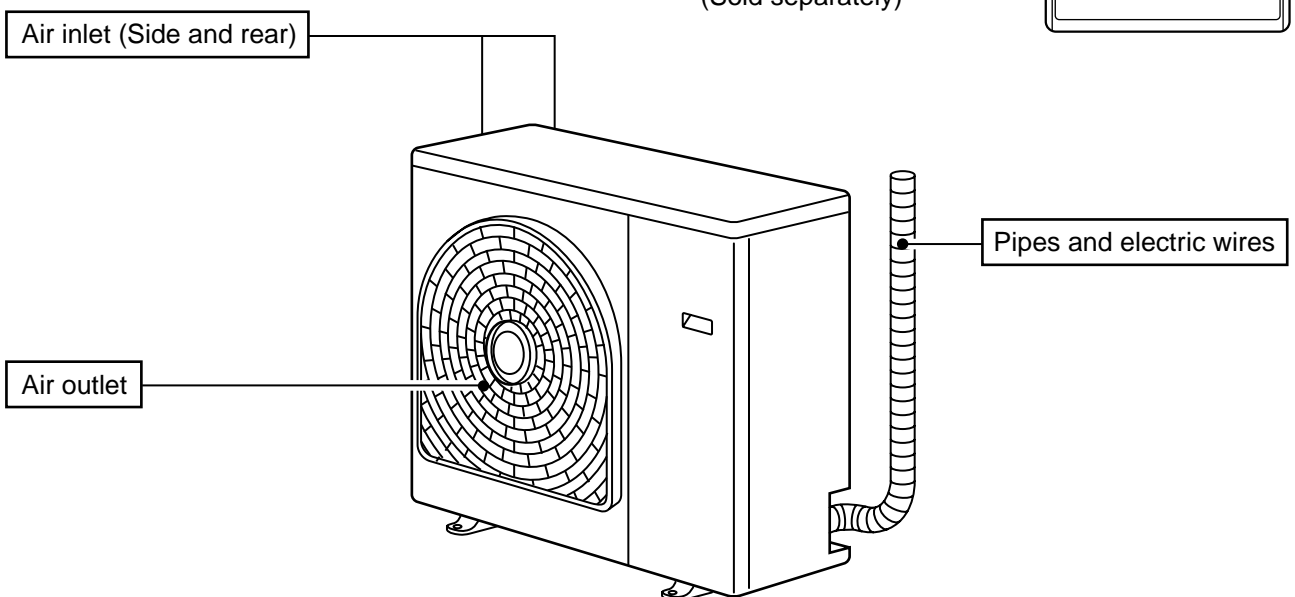

PARTS NAME OF REMOTE CONTROLLER

Display section

All display items are shown in right figure for the explanation.

Only selected contents are displayed in actual operation.

- When turning on the leakage breaker at the first time, [SET DATA] flashes on the display part of the remote controller. While this display is flashing, the model is being automatically confirmed. Accordingly, wait for a while after [SET DATA] display has disappeared, and then use the remote controller.

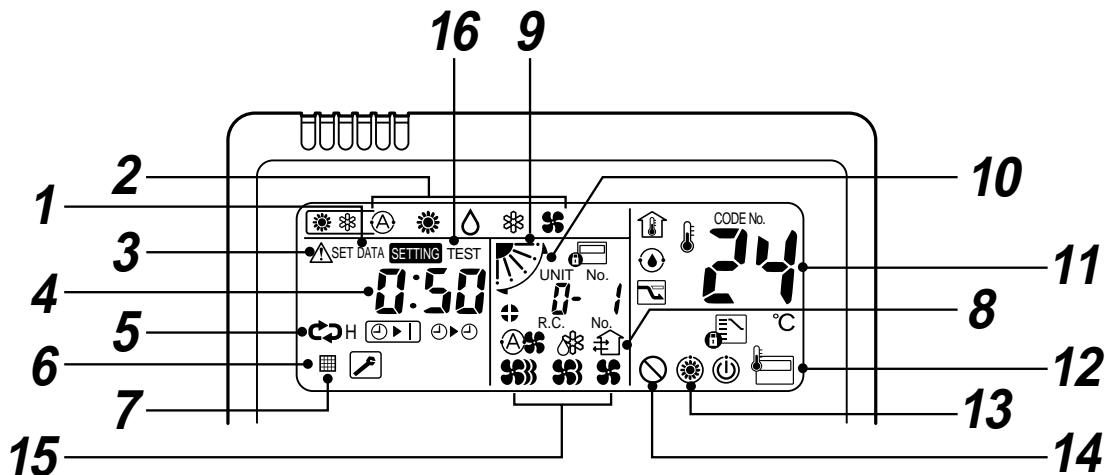
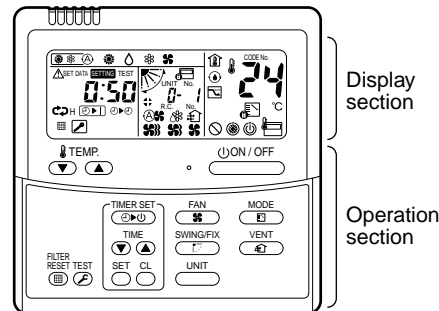

1 SET DATA display

Displayed during setup a timer.

2 Operation mode display

The selected operation mode is displayed.

3 CHECK display

Displayed while the protective device works or a trouble occurs.

4 Timer time display

Set time by the timer is displayed.
(When a trouble occurs, the check code is displayed.)

5 Timer SETIN setup display

When pushing the Timer SET button, the display of the timer is selected in order of [OFF] [ON] → [OFF] repeat OFF timer → [ON]
→ [ON]
→ No display.

6 Filter display

If "FILTER" is displayed, clean the air filter.

7 UP/DOWN grille display

8 Ventilator operation display

9 Flap position display

10 SWING display

Displayed during up/down movement of the flap.

11 Set up temperature display

The selected set up temp. is displayed.

12 Remote controller sensor display

Displayed while the sensor of the remote controller is working.

13 PRE-HEAT display

Displayed when the heating operation starts or defrost operation is carried out.





While this indication is displayed, the indoor fan stops or the mode changes in LOW.

14 No function display

Displayed if there is no function even if the button is pushed.

15 Fan mode display

The selected fan mode is displayed.

(AUTO) 
(HIGH) 
(MED.) 
(LOW) 

16 TEST run display

Displayed during a test run.

Operation section

Push each button to select a desired operation.

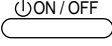
- The details of the operation needs to be set up once, the same states are used by pushing  button.

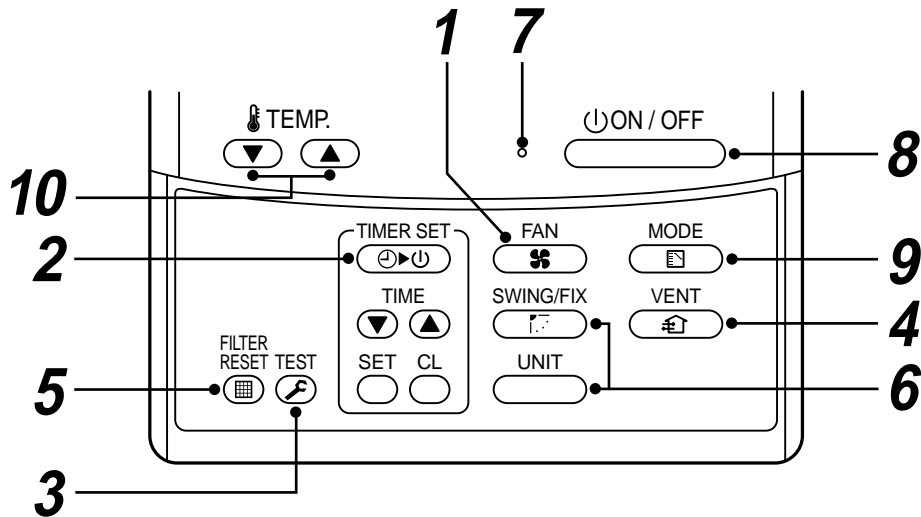

1 Fan mode button

Selects a fan mode.

2 Timer set button

TIMER SET button is used when the timer is set up.

3 Check button

CHECK button is used for check operation. During normal operation, do not use this button.

4 Fan button

FAN button is used when a fan which is sold on the market or etc. is connected.

- If "No function  " is displayed on the remote controller when pushing the FAN button, a fan is not connected.

5 Filter reset button

Resets (Erases) "FILTER  " display.

6 UNIT and AUTO flap button

No function

7 Operation lamp

Lamp is lit during the operation. Lamp is off when stopped.

It flashes when operating a protection device or abnormal occurred.

8 button

When the button is pushed, operation starts, and it stops by pushing the button again.

When the operation stops, the operation lamp and all displays disappear.

9 Operation select button

Selects operation mode.

10 Set up temperature button

Adjusts required room temperature.

Set required set temperature by pushing

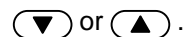

FILTER UP/DOWN button

(No function display)

OPTION :

Remote controller sensor

Usually the TEMP. sensor of the indoor unit measures a temperature. A temperature around the remote controller can also be measured.

For details, contact the dealer from which you have purchased the air conditioner.

CORRECT USAGE

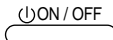
When you use the air conditioner for the first time or when you change SET DATA value, follow the procedure below. From the next time, the operation will start as set state by pushing the  button.

Preparation

Turn on the main power switch and/or the leakage breaker.

- When the power supply is turned on, display section is displayed on the remote controller.
- * After the power supply is turned on, the remote controller does not accept an operation for approx. 1 minute, but it is not a failure.

REQUIREMENT

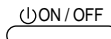
- While using the air conditioner, operate it only with  button without turning off the main power switch and the leakage breaker.
- When starting the operation after stop for a long time, turn on the main power switch for 12 hours or more before start. (This is required to turn on the compressor case heater for warming in order to prevent overload on the compressor when activating the outdoor unit.)

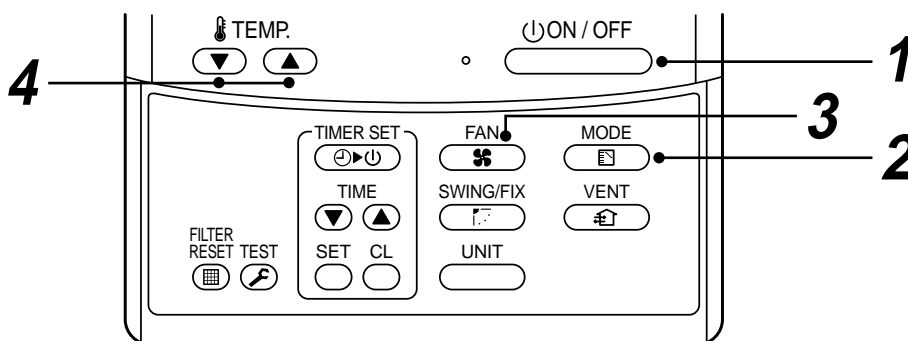



1 Push button.

The operation lamp goes on, and the operation starts.

2 Select an operation mode with the “MODE ” button.

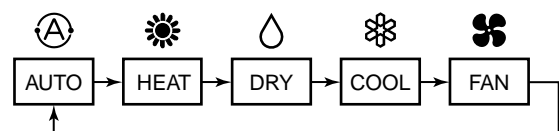
One push of the button, in each time the display changes in the order shown on the right.









- In HEAT  mode, if the room temperature reaches to the set temperature, the outdoor unit stops and the air flow becomes LOW and the air volume decreases.
- In the defrost mode, the fan stops so that cool air is not discharged and PRE-DEF  is displayed.



3 Select air volume with “ ” button.

One push of the button, in each time the display changes in the order shown on the right.

- When air volume is “AUTO  ”, air volume differs according to the room temperature.
- In DRY  mode, “AUTO  ” is displayed and the air volume is LOW.
- In heating operation, if the room temperature is not heated sufficiently with fan mode “LOW  ” operation, select “MED.  ” or “HIGH  ” operation.

4 Determine the set up temperature by pushing the “TEMP. ” or “TEMP. ” button.

Stop

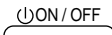
Push  button.

The operation lamp goes off, and the operation stops.

AUTOMATIC OPERATION (Auto Changeover)

When you set the air conditioner in A mode or switch over from AUTO operation, it will automatically select either cooling, heating, or fan only operation depending on the indoor room temperature.

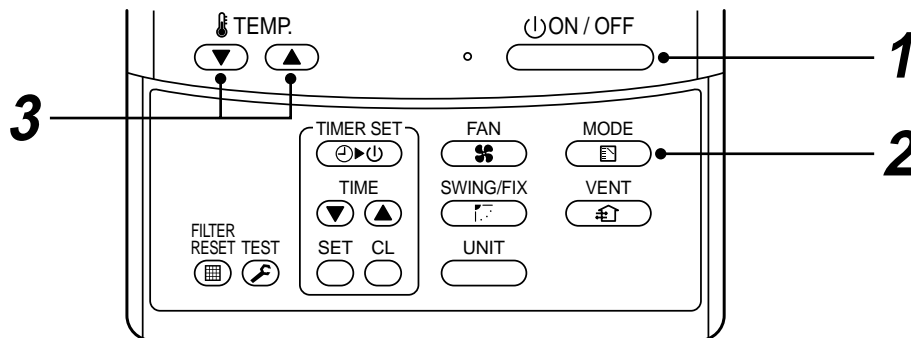

Start

1 ON/OFF button

Push this button to start the air conditioner.

2 Mode select button (MODE)

Select Auto.

3 Temperature button

Set the desired temperature.

- In case of cooling, start the operation after approx. 1 minute.
- In case of heating, starts the operation after approximately 3 to 5 minutes.
- When you select the Auto mode, it is unnecessary to set the fan speed. The fan speed display will show A and fan speed will be automatically controlled.
- After heating operation stops, FAN operation may continue for approx. 30 seconds.
- When the room temperature reaches the set temperature and the outdoor unit stops, the LOW wind is discharged and the air volume decreases excessively. During defrost operation, the fan stops so that cool air is not discharged and A is displayed.
- If the Auto mode is uncomfortable, you can select the desired conditions manually.

NOTE

When restarting the operation after stop

- When restarting the operation immediately after stop, the air conditioner does not operate for approx. 3 minutes to protect a compressor.

Stop

Push ON/OFF button.

Push this button again to stop the air conditioner.

TIMER OPERATION

A type of timer operation can be selected from the following three types.

OFF timer : The operation stops after the set time has passed.

Repeat OFF timer : Every time, the operation stops after the set time has passed.

ON timer : The operation starts after the set time has passed.

Timer operation

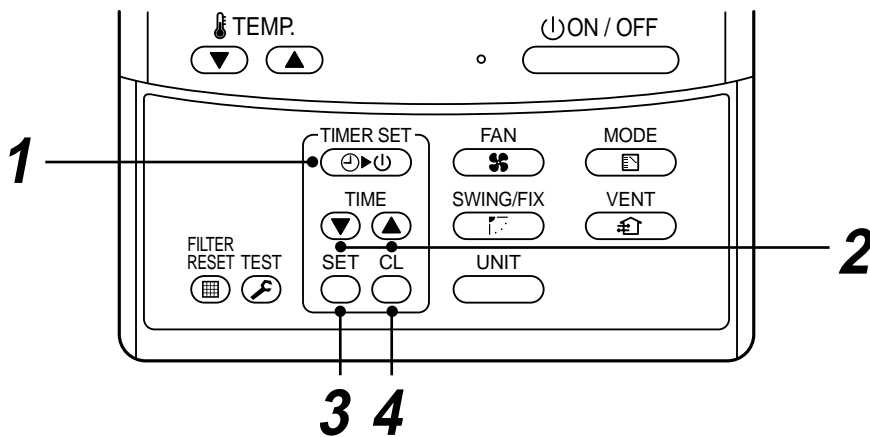

1 Push TIMER SET button.

- The timer display (type) changes every push of the button.
- SET DATA and timer time displays flash.

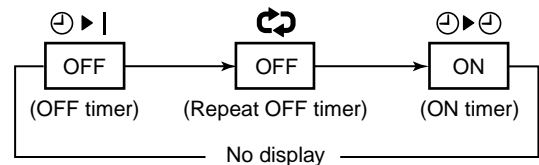

2 Push TIME to select "SET TIME".

For every push of \blacktriangle button, the set time increases in the unit of 0.5 hr (30 minutes).

The maximum set time is 72.0 hr.

For every push of \blacktriangledown button, the set time decreases in the unit of 0.5 hr (30 minutes).

The minimum set time is 0.5 hr.

3 Push SET button.

- **SETTING** display disappears and timer time display goes on.
(When ON timer is activated, timer time, ON timer ON are displayed and other displays disappear.)

Clear of timer operation

4 Push CL button.

- TIMER display disappears.

NOTICE

- Once set "Repeat OFF timer" resumes. So start again, stop by same timer.
For cancel timer, push CL button.

HINTS FOR ECONOMICAL OPERATION

Maintain room temperature at comfortable level

Clean air filters

Airflow and performance are reduced if the air filters become blocked.

Do not open doors and windows more often than necessary

To keep cool or warm air in the room, do not open doors and windows more often than necessary.

Window curtains

In cooling, close the curtains to avoid direct sunlight.

In heating, close the curtains to keep the heat in.

Get uniform circulation of room air

Adjust the air flow direction for the even circulation of room air.

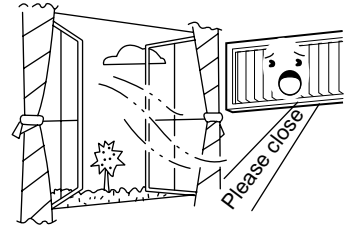
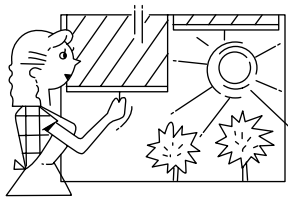
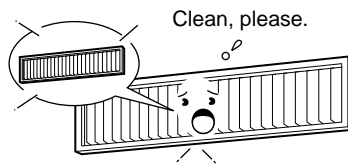
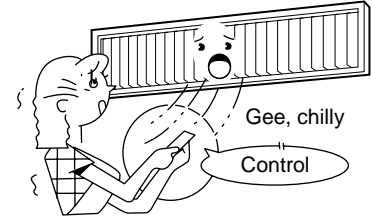

Blows upward

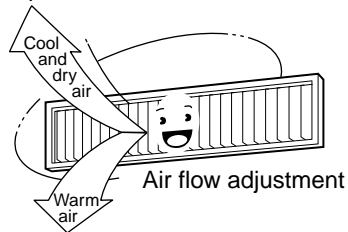

Blows downward

MAINTENANCE

Cleaning of remote controller

CAUTION

- Use a dry cloth to wipe the remote controller.
- A cloth dampened with cold water may be used on the indoor unit if it is very dirty.
- Never use a damp cloth on the remote controller.
- Do not use a chemically-treated duster for wiping or leave such materials on the unit for long. It may damage or fade the surface of the unit.
- Do not use benzine, thinner, polishing powder, or similar solvents for cleaning. These may cause the plastic surface to crack or deform.

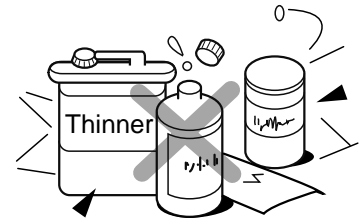

If you do not plan to use the unit for more than 1 month

- (1) Operate the fan for 3 to 4 hours to dry inside the unit
Operate "FAN ONLY" mode with set temperature 30°C.
- (2) Stop the air conditioner and turn off the main power switch or the circuit breaker.

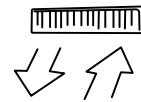

Checks before operation

- (1) Check that the air filters are installed.
- (2) Check that the air outlet or inlet is not blocked.
- (3) Turn on the main power switch or the circuit breaker for the main power supply to the air conditioner.



FAN ONLY operation

WARNING

Cleaning of the air filter and other parts of the air filter involves dangerous work in high places, so be sure to have a service person do it. Do not attempt it yourself.

NOTE

For Air conditioning system which is operated regularly, cleaning and maintenance of the indoor/outdoor units are strongly recommended.
As a general rule, if an indoor unit is operated for about 8 hours daily, the indoor/outdoor units will need to be cleaned at least once every 3-MONTH. This cleaning and maintenance shall be carried out by a qualified person.
Failure to clean the indoor/outdoor units regularly will result in poor performance, icing, water leaking and even compressor failure.

AIR CONDITIONER OPERATIONS AND PERFORMANCE

3 minutes protection function

3-minutes protection function prevents the air conditioner from starting for initial 3 minutes after the main power switch/circuit breaker is turned on for re-starting the air conditioner.

Power failure

Power failure during operation will stop the unit completely.

- To restart the operation, push the START/STOP button on the remote controller.
- Lightning or a wireless car telephone operating nearby may cause the unit to malfunction. Turn off the main power switch or circuit breaker and then turn them on again. Push the START/STOP button on the remote controller to restart.

Heating characteristics

Preheating operation

The air conditioner will not deliver warm air immediately after it is turned on. Warm air will start to flow out after approximately 5 minutes when the indoor heat exchanger warmed up.

Warm air control (In heating operation)

When the room temperature reaches the set temperature, the fan speed is automatically reduced to prevent to blow cold draft. At this time, the outdoor unit will stop.

Defrosting operation

If the outdoor unit is frosted during the heating operation, defrosting starts automatically (for approximately 2 to 10 minutes) to maintain the heating capacity.

- The fans in both indoor and outdoor units will stop during the defrosting operation.
- During the defrosting operation, the defrosted water will be drained from the bottom plate of the outdoor unit.

Heating capacity

In the heating operation, the heat is absorbed from the outside and brought into the room. This way of heating is called heat pump system. When the outside temperature is too low, it is recommended to use another heating apparatus in combination with the air conditioner.

Attention to snowfall and freeze on the outdoor unit

- In snowy areas, the air inlet and air outlet of the outdoor unit are often covered with snow or frozen up. If snow or freeze on the outdoor unit is left as it is, it may cause machine failure or poor warming.
- In cold areas, pay attention to the drain hose so that it perfectly drains water without water remaining inside for freeze prevention. If water freezes in the drain hose or inside the outdoor unit, it may cause machine failure or poor warming.

Air conditioner operating conditions

For proper performance, operate the air conditioner under the following temperature conditions:

Cooling operation	Outdoor temperature : -15°C to 43°C
	Room temperature : 21°C to 32°C (Dry valve temp.), 15°C to 24°C (Wet valve temp.)
	CAUTION Room relative humidity – less than 80 %. If the air conditioner operates in excess of this figure, the surface of the air conditioner may cause dewing.
Dry operation	Outdoor temperature : 15°C to 43°C (Maximum suction air temp. 46°C)
	Room temperature : 17°C to 32°C
Heating operation	Outdoor temperature : -15°C to 15°C (Wet valve temp.)
	Room temperature : 15°C to 28°C (Dry valve temp.)

If air conditioner is used outside of the above conditions, safety protection may work.

RE-INSTALLATION

DANGER

Ask the dealer or an installation professional to re-install the air conditioner to a new place or move it to another place and to observe the following items.

If the air conditioner is inappropriately installed by yourself, it may cause electric shock or fire.

Do not install the air conditioner in the following places

- Do not install the air conditioner in any place within 1 m from a TV, stereo, or radio set. If the unit is installed in such place, noise transmitted from the air conditioner affects the operation of these appliances.
- Do not install the air conditioner near a high frequency appliance (sewing machine or massager for business use, etc.), otherwise the air conditioner may malfunction.
- Do not install the air conditioner in a humid or oily place, or in a place where steam, soot, or corrosive gas is generated.
- Do not install the air conditioner in a salty place such as seaside area.
- Do not install the air conditioner in a place where a great deal of machine oil is used.
- Do not install the air conditioner in a place where it is usually exposed to strong wind such as in seaside area or on the roof or upper floor of a building.
- Do not install the air conditioner in a place where sulfurous gas generated such as in a spa.
- Do not install the air conditioner in a vessel or mobile crane.

Be careful with noise or vibrations

- Do not install the air conditioner in a place where noise by outdoor unit or hot air from its air outlet annoys your neighbors.
- Install the air conditioner on a solid and stable foundation so that it prevents transmission of resonating, operation noise and vibration.
- If one indoor unit is operating, some sound may be audible from other indoor units that are not operating.



TROUBLES AND CAUSES

CAUTION

If any of the following conditions occur, turn off the main power supply switch and immediately contact the dealer :

- The operation lamps flash at short intervals (5 Hz) even though you have tried turning off the power supply and turning on again after 2 or 3 minutes.
- Switch operation does not work properly.
- The main power fuse often blows out, or the circuit breaker is often activated.
- A foreign matter or water fall inside the air conditioner.
- Any other unusual conditions are observed.

Before you ask for servicing or repairs, check the following points.

Recheck

Inoperative

- The main power switch is turned off.
- The circuit breaker is activated to cut off power supply.
- The main power fuse has blown out.
- Stoppage of electric current.

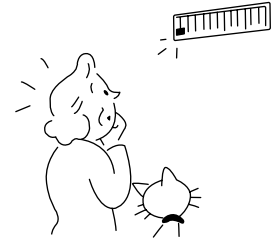

Does not cool well or heat well

- The air inlet and/or outlet of the outdoor unit is blocked.
- Doors or windows are opened.
- The fan speed is set to low.
- The air conditioner is set in the DRY mode.
- The set temperature is too high. (In cooling operation)
- The set temperature is too low. (In heating operation)



These are not failures.

Indoor unit or outdoor unit makes a strange noise.

- When the temperature suddenly changes, the indoor or outdoor unit occasionally makes a strange noise because of changing of refrigerant flow or expansion work.

The room air is smelly or a bad odor comes from the air conditioner.

- Smells impregnated in the walls, carpets, furniture, clothing, or furs, come out from the air conditioner.

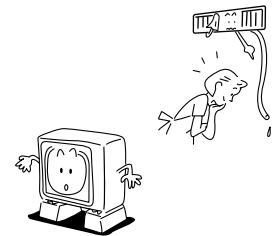

Outdoor unit is frosted in heating operation.

Water drains from outdoor unit.

- The outdoor unit is sometimes frosted in heating operation.
In that case, the unit automatically performs defrosting (for 2 to 10 minutes) for increasing the heating efficiency.
- In defrosting operation, both the indoor and outdoor units stop air flow.
- Hiss sound is heard when flow of the refrigerant is changed for defrosting.
- Resultant water of automatic defrosting in heating operation drains from outdoor unit.



Air flow changes without FAN button set to AUTO mode.

- When the temperature of blown air drops in heating operation, the air conditioner automatically changes or stops air flow from the indoor unit not to make persons in the room feel chilly.
- Air flow of the indoor unit is occasionally changed in the cooling operation.



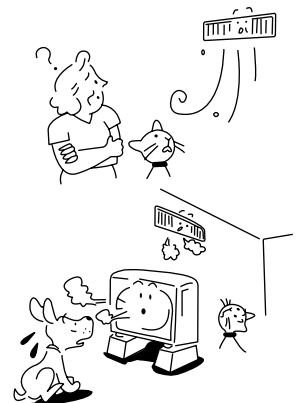

A white mist of chilled air or water is generated from the outdoor unit.

- The indoor unit in cooling operation or the outdoor unit in defrosting operation occasionally cause steams.



TROUBLES AND CAUSES (Concerning Remote Controller)

Before you ask for servicing or repairs, check the following points:

Setting Change is Impossible		
Symptoms	Causes	Reason and Disposal
The fan speed can not be changed.	<ul style="list-style-type: none"> Check whether the MODE indicated on the display is "AUTO". <p style="text-align: center;">AUTO </p>	When the automatic mode is selected, the air conditioner automatically selects the fan speed.
	<ul style="list-style-type: none"> Check whether the MODE indicated on the display is "DRY". <p style="text-align: center;">(DRY) </p>	When dry operation is selected, the air conditioner automatically selects the fan speed.

TOSHIBA CARRIER CORPORATION
2 CHOME 12-32, KONAN, MINATOKU, TOKYO, 108-0075, JAPAN